

2015 COMFORT COLLECTION

INTERNATIONAL Intex Development Co., Ltd. 9th Floor, Dah Sing Financial Centre, 108 Gloucester Road, Wanchai, Hong Kong Tel: (852) 2827-0000 Fax: (852) 2311-8200 E-mail: info@intexdevelopment.com Web: www.intexdevelopment.com	USA Intex Recreation Corp. P.O. Box 1440 Long Beach, CA 90801-1440 USA Tel: (310) 549-5400 Fax: (310) 513-6905 Web: www.intexcorp.com	EUROPE Intex Trading B.V. Venneveld 9, 4705 RR Roosendaal, The Netherlands Tel: (31) 165-593920 Fax: (31) 165-593969 E-mail: info@intexcorp.nl Web: www.intexcorp.nl	Intex Trading s.r.o. Benešovská 23 101 00 Praha 10 Czech Republic Tel: (420) 267 312 645 Fax: (420) 267 312 552 E-mail: info@intexcorp.cz Web: www.intexdevelopment.com	Unitex Service (France) S.A.S. Z.A. de Milleure Bois du Ban - N°4 71480 LE MIROIR, France Tel: (33) 385 75 64 64 Fax: (33) 385 75 64 65 E-mail: info@intexcorp.com.fr Web: www.intex.fr
--	---	---	--	---

INTEX®

©2014 Intex Marketing Ltd. - Intex Development Co., Ltd. - Intex Trading Ltd. - Intex Recreation Corp. All rights reserved. • Printed in China
®™ Trademarks used in some countries of the world under license from Intex Marketing Ltd. to Intex Trading Ltd., Intex Development Co., Ltd.,
G.P.O Box 28829, Hong Kong, and Intex Recreation Corp., P.O. Box 1440, Long Beach, CA 90801.



COMFORT REST®

INTEX®

2015 COMFORT COLLECTION

2015



INTRODUCTION

The Intex Family of companies is dedicated to developing and manufacturing the highest quality products that not only provide the best value in price, but are innovative, fun and exciting. Backed by excellent Customer Service, Intex also provides first-rate after sales support. The 100+ independently owned and locally operated companies that make up the Intex Family, all embrace this commitment to quality, service and price and are committed to working together to ensure the satisfaction of the families and individuals across the globe who enjoy these products. This has become the hallmark of Intex around the world.

As a true industry leader, Intex boasts state of the art factories, trained and motivated people, products that meet rigorous testing requirements, and a Customer Service organization that will go extra lengths to ensure our customers are satisfied and happy with their purchases.

When you purchase an Intex product you can be confident that you are buying the best product, at the best price, backed by the best Customer Service organization in the industry.

Intex is committed to delivering top quality products at a great value with the backing of a responsive Customer Service organization. Our Airbed line is unmatched for breadth and beauty. With the introduction of our new innovative, patented Fiber-Tech™ Technology, we have engineered a way to combine durability with exceptional comfort, creating airbeds that rival the stability, support and comfort of a traditional mattress. The “Dura-Beam®” series utilizes superior Fiber-Tech™ interior construction to create a line of airbeds that are lighter, stronger, and more comfortable than an average airbed. With “PremAire™”, Intex has combined our manufacturing technologies with our engineering strengths of Fiber-Tech™ to bring you the most innovative, luxurious, and comfortable bed in the market today.

Our standard Comfort Rest® line consists of four series designed to meet all of your customers' needs: the “Outdoor” series is engineered for camping, travel, and all-around rugged use. It features stain-resistant materials, with beds perfectly suited to the outdoor environment. The “Inhome” series offers a wide selection of standard height and raised beds in a range of colors, sizes, and accessories to fit all decors and budgets. The “Premium” series features a wide variety of luxurious premium quality raised airbeds. Each airbed has been engineered and tested to provide you with superior functionality that guarantees the ultimate sleeping experience. And for the young at heart, our “Air Furniture” series comes with bright colors and fresh design concepts, guaranteed to attract a loyal following of young adults! Ask your Intex representative for any of our product catalogs – we are confident that you will agree that Intex's product line is unmatched in meeting your needs.

COMMITMENT TO EXCELLENCE

In today's rapidly evolving and highly competitive environment, this translates into a total commitment to product quality, including conformity to all relevant safety & quality regulations and standards. Examples include:

- Regulation (EC) No.1907/2006 "Registration, Evaluation, Authorisation and Restriction of Chemicals (REACH)"
- EN 71 "Safety of toys" (European standard)
- EN 13138 "Buoyant aids for swimming instruction" (European standard)
- EN15649 "Floating leisure articles for use on and in the water" (European standard for air mats, lounges and other similar items)
- EN 60335-2-41 "Safety of household and similar electrical appliances, particular requirements for pumps" (European standard for water pumps)
- ISO 6185-1 "Inflatable boats" (International standard for Sports Boats)
- NMMA-ABYC (USA standard for hi-end sports boats)
- ASTM F963 "Standard Consumer Safety Specification for Toy Safety" (USA toy standard)
- ANSI/APSP-4 "AGP standard" (USA standard for above ground pools)
- CPSIA "Consumer Product Safety Improvement Act" (USA regulation of consumer and children's products)
- ASTM F2666 "Small pools standard" (USA standard for pools under 36" water depth)
- UL1450 "Electric inflators" (USA standard for electric inflators)
- UL1081 "Swimming pool pumps, filters and chlorinators" (USA standard)
- UL1563 "Electric Spas" (USA standard for Spa)

Intex's commitment to Excellence extends to helping our environment and supporting the ecosystem. It begins with product design. Intex's filter pumps operate on much lower amps than most filter pumps in the market, reducing electricity consumption. Our saltwater systems clean pools using only natural salt, eliminating the ongoing need for environmentally unfriendly packaged chlorine.

Intex also operates one of the most comprehensive recycling programs in the industry. We are the first company in China to successfully obtain a license to ship consumers' returns in the original package back to China to be recycled. Therefore, used materials and product returns are prevented from going to landfills and instead re-used in the manufacturing process where up to 10% of annually produced PVC is recycled.

Intex designs all of our own packaging for our products. We constantly challenge our methods of packaging to improve efficiency and reduce waste. More compact packaging techniques save cardboard while cutting down on space utilization, saving freight and fuel consumption.

As a manufacturer, Intex knows it has a responsibility to manage the amount of waste produced. As an employer of over ten thousand people, we also encourage our own employees to recycle, reduce waste, and be conscious of the environment. Starting from recycling corners for all our worldwide office facilities, our Factory has worked with the local government as well as through sponsorships with key partners to strengthen our efforts to be more eco-friendly. Intex has worked to provide incentives and seminars to employees as well as setting targets to reduce energy consumption. In addition, Intex has made significant investment in technology to achieve these goals. For example, we have implemented a frequency converter system which converts diesel to natural gas, installed solar water heaters and set up a recycled sewage system, and invested in equipment that reduces gas emissions.

From product design, to more efficient processes that save energy and reduce waste, to a world class recycling program, to more energy efficient offices, the people at Intex are striving to provide the best value products anywhere while constantly keeping our global ecosystem in mind.



100% of our airbeds are quality tested to be air tight before they leave our factory.

Intex's commitment to Excellence encompasses every single product that leaves our factory. We achieve this by maintaining the highest levels of quality assurance – such as inflating and testing every single airbed to ensure the Air Lock® guarantee. It's that simple.

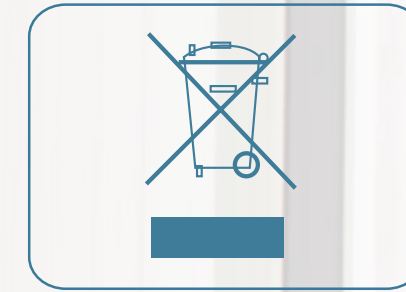

2015



08	Fiber-Tech™ Technology
12	Dura-Beam®
20	PremAire™
24	Outdoor
32	Inhome
40	Premium
48	Air Furniture
68	Accessories



100% of our airbeds are quality tested to be air tight before they leave our factory.

INTRODUCING

FIBER-TECH™ TECHNOLOGY

by INTEX®

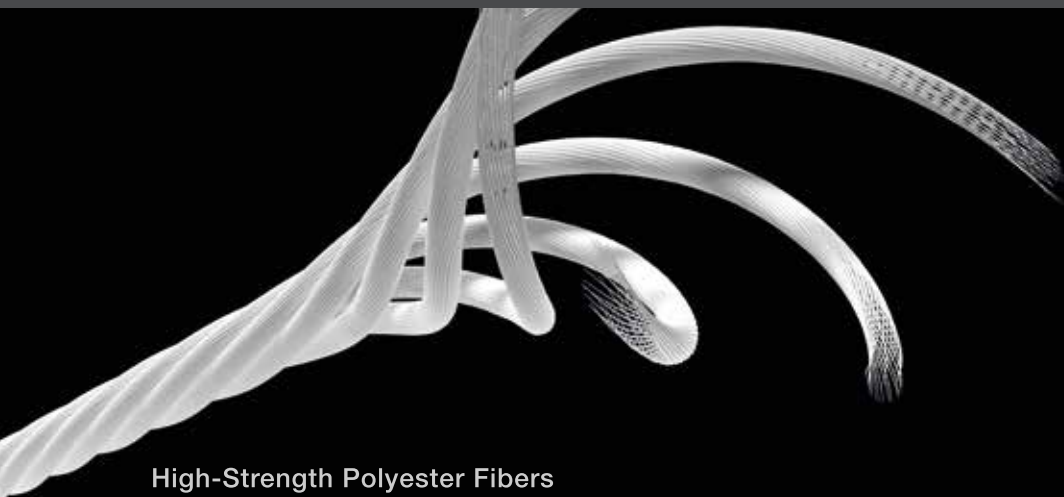

High-Strength Polyester Fibers

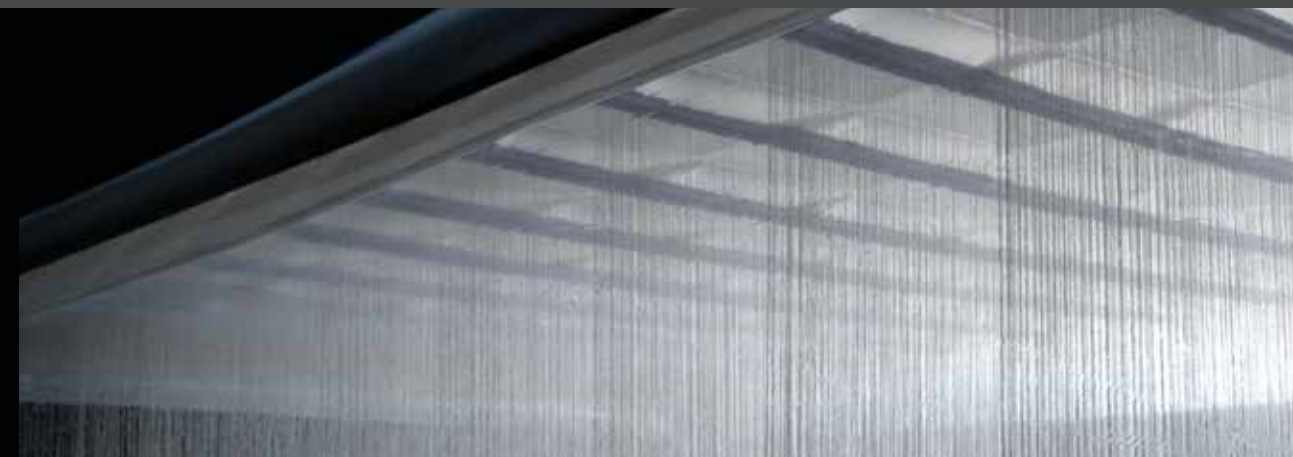

Fiber-Tech™ Interior Construction

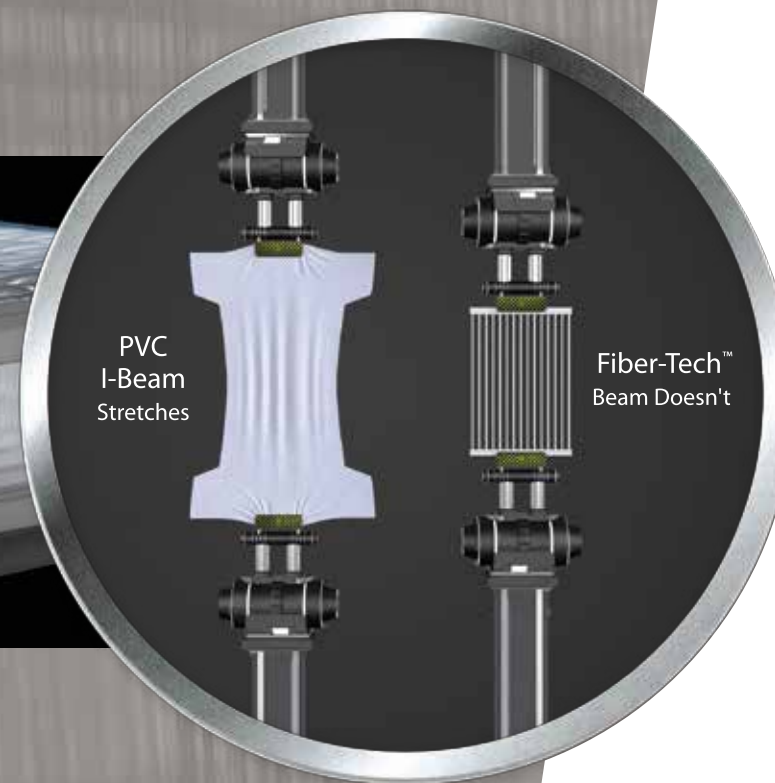

An Incredible Night's Sleep Starts With a Single Thread...

CONTOURED SUPPORT SYSTEM

Our new innovative, patented Fiber-Tech™ Technology airbeds are comprised of thousands of high-strength polyester fibers. Unlike traditional airbed construction, these high-strength polyester fibers do not stretch over time, resulting in amazing durability for years of lasting comfort. Fiber-Tech™ interior construction provides the ideal firmness for superb support and rejuvenating sleep.



Designed for Comfort
Engineered for Durability

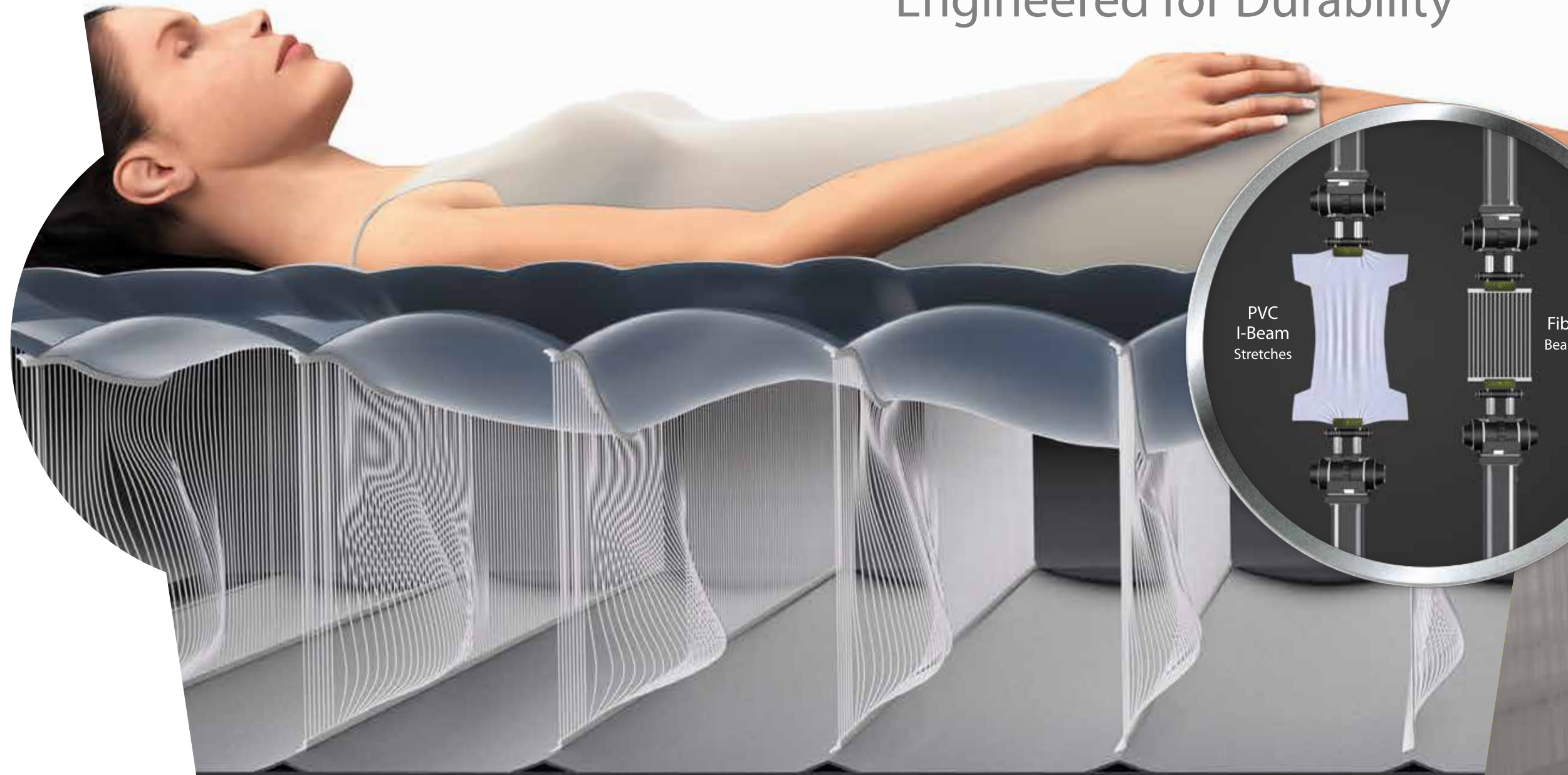

FIBER-TECH™ TECHNOLOGY

Standard interior construction has been enhanced with lightweight, high-strength fibers for amazing durability and comfort!

U.S. Patent No. 8,562,773

ROLL 'N GO™ BED

WITH FIBER-TECH™ TECHNOLOGY

Our newly redesigned Roll 'N Go™ bed offers the perfect ultra light weight sleep solution for your next camping trip.

This PVC-free laminated bed is built with our new, patented Fiber-Tech™ technology. Combined with an extra-strong, lightweight TPU outer surface, this bed is ultra strong, ultra light, and ultra convenient. Perfect for the great outdoors! For extra convenience, the Roll 'N Go™ Bed comes with a hand-held manual air pump.

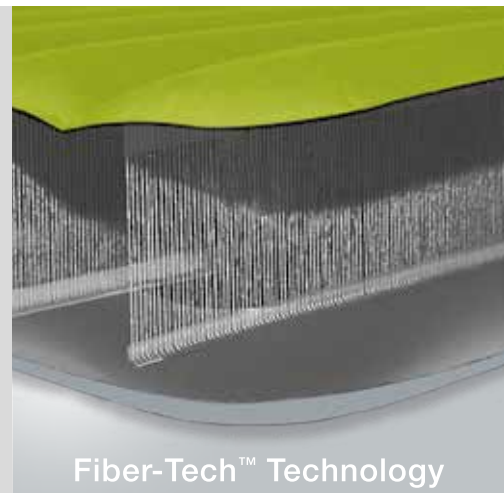
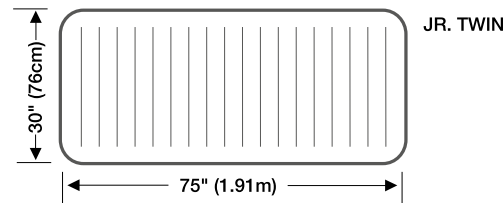

Fiber-Tech™ Technology



Hand Pump (#68612)

ULTIMATE OUTDOOR BED WITH PUMP

- Eco-friendly TPU laminated fabric – phthalate-free material
- Fiber-Tech™ interior construction
- Hand-held hi-output lightweight manual air pump
- Folds compactly for storage
- Duffel bag with handle included
- Shelf box

This PVC Free airbed is constructed of laminated TPU, which means it is:

- Super Tough – Softens up the rough outdoors with a very durable, eco-friendly material
- Strong Support System – Inflates up to three times the pressure of a regular PVC junior-twin airbed for a firmer sleeping surface
- Ultra Lightweight – Weighs approximately one fourth less than a common junior-twin PVC constructed airbed

AIRBED WITH HAND PUMP

Item	Size	Approximate Inflated Size	Hand Pump	Case Pack	Case Weight
64780 / E	JR.Twin	30" x 75" x 5" (76cm x 1.91m x 13cm)	68612	4 ea	21.9 lb (10.0 kg)

NO PVC

MAXIMUM DURABILITY

The strong TPU (Thermoplastic Polyurethane) laminated material and innovative Fiber-Tech™ inner construction transform the toughest ground into a refreshing night's sleep. It retains elasticity in temperature as low as -4° F/-20° C.

Made of TPU – A PVC-free eco-friendly material

SUPER-TOUGH™ AIRBED

WITH FIBER-TECH™ TECHNOLOGY

Introducing the Intex Super-Tough™ airbed with a brand-new colorful look. Bright and bold, this compact airbed provides campers with the ultimate camping experience.

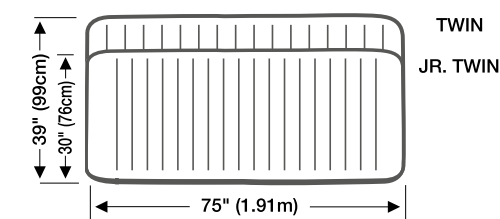

The Super-Tough™ PVC and polyester laminate create a smooth, yet strong sleeping surface, guaranteed to give campers a great night's sleep. High-strength Fiber-Tech™ fibers make up the inner construction and are combined with a puncture resistant laminated surface to make this camping airbed very strong, comfortable, and long-lasting.

For the ultimate in convenience, the Super-Tough™ bed is also available with a built-in 6 C-cell battery pump.

AIRBED ONLY

Item	Size	Approximate Inflated Size	Case Pack	Case Weight
64790 / E	JR. Twin	30" x 75" x 6" (76cm x 1.91m x 15cm)	6 ea	29.1 lb (13.2 kg)

AIRBED WITH BUILT-IN BATTERY PUMP

Item	Size	Approximate Inflated Size	Case Pack	Case Weight
64791 / E	Twin	39" x 75" x 8" (99cm x 1.91m x 20cm)	3 ea	24.6 lb (11.2 kg)

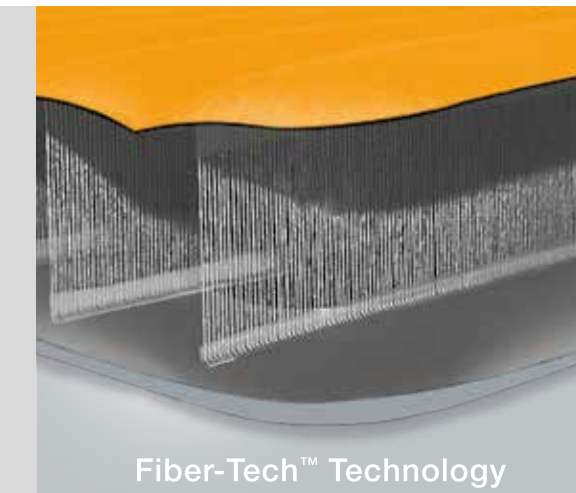

Fiber-Tech™ Technology

STRENGTH, LIGHT-WEIGHT, CONVENIENCE & COMFORT

- Brand-new, bright and bold outdoor color
- Super-Tough™ laminated exterior surfaces
- Fiber-Tech™ interior construction
- Includes carry bag
- Folds compactly for storage
- Shelf box



Perfect for camping with 6 C-cell batteries (not included) (#64791/E)

DELUXE SINGLE-HIGH

WITH FIBER-TECH™ TECHNOLOGY

Introducing a new deluxe single high airbed with Fiber-Tech™ inner construction that can be used both indoors and outdoors. Recognizably many times more comfortable and durable than a traditional PVC air mattress, this entry level airbed is the perfect addition to any home.

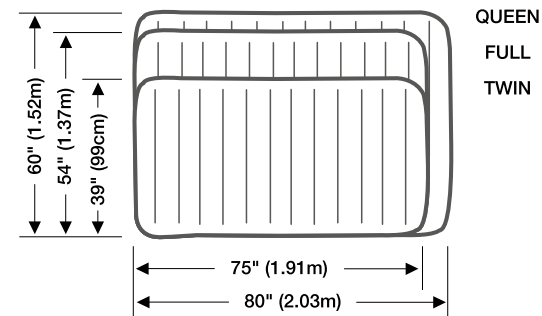

QUEEN
FULL
TWIN

AIRBED ONLY

Item	Size	Approximate Inflated Size	Case Pack	Case Weight
64701 / E	Twin	39" x 75" x 10" (99cm x 1.91m x 25cm)	4 ea	24.4 lb (11.1 kg)
64702 / E	Full	54" x 75" x 10" (1.37m x 1.91m x 25cm)	3 ea	24.6 lb (11.2 kg)
64703 / E	Queen	60" x 80" x 10" (1.52m x 2.03m x 25cm)	3 ea	29.5 lb (13.4 kg)



new!

INDOOR / OUTDOOR MULTI-USE SINGLE-HIGH AIRBED

- Fiber-Tech™ Technology
- Quality tested waterproof flocked top and sides with vinyl bottom
- Strong and lightweight
- 2 in 1 valve
- Folds compactly for storage or travel
- Air Lock® tested
- Shelf box

Innovative Fiber-Tech™ Technology airbeds are comprised of thousands of high-strength polyester fibers. Unlike traditional airbed construction, these high-strength polyester fibers do not stretch over time, resulting in amazing durability for years of lasting comfort. Fiber-Tech™ interior construction provides the ideal firmness for super support and rejuvenating sleep.

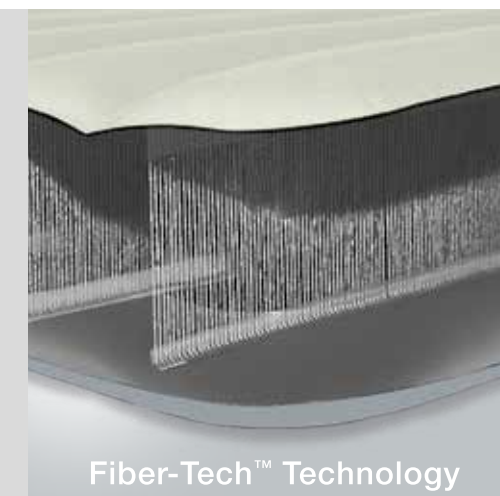

Fiber-Tech™ Technology

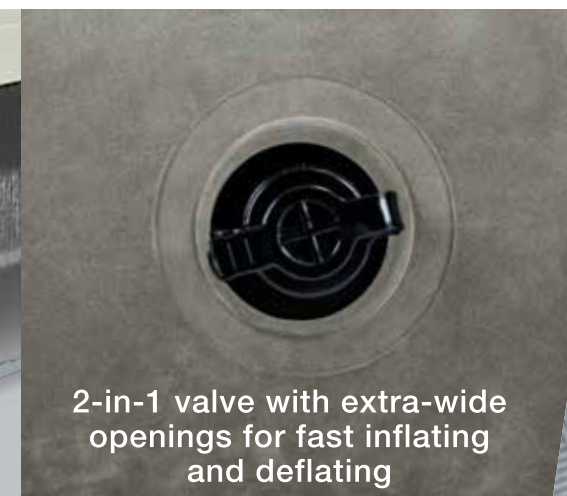

2-in-1 valve with extra-wide openings for fast inflating and deflating

Introducing the new 10" (25cm) Deluxe Single-High Airbed with Fiber-Tech™ Technology. The perfect all-around sleeping solution, this compact airbed provides both campers and in-home users with the convenience of a low-profile, light-weight, comfortable bed that is built for long-lasting durability.

This airbed is covered in a soft, flocked sleeping surface for enhanced comfort. Our patented Fiber-Tech™ interior construction provides superb support and structural stability for a restful night's sleep. Made for durability and comfort, anywhere you go.

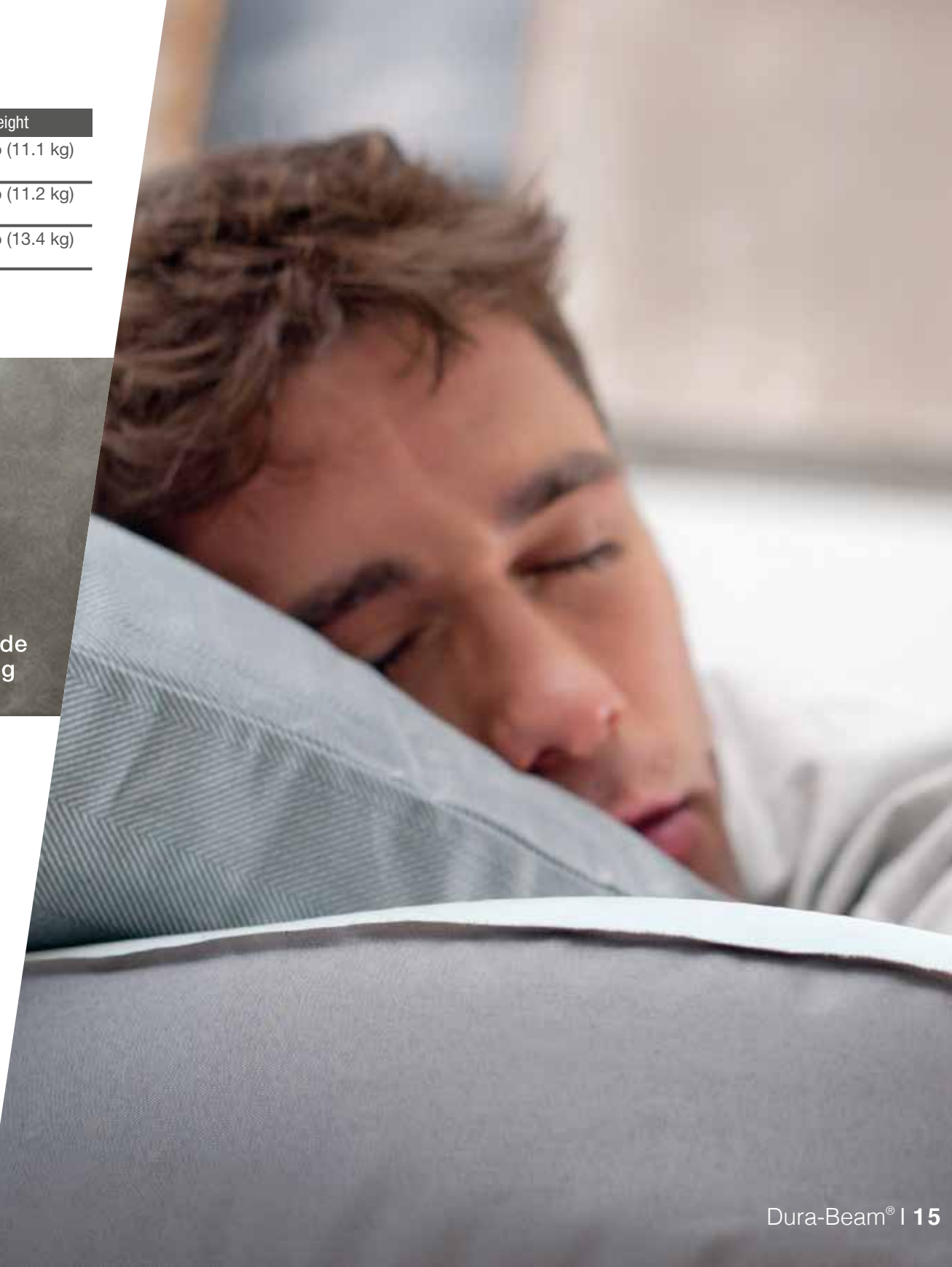

COMFORT-PLUSH

WITH FIBER-TECH™ TECHNOLOGY

Our most popular bed in the Dura-Beam® series with three different bed heights to choose from, our Comfort-Plush beds offer the perfect combination of luxurious comfort and convenience.

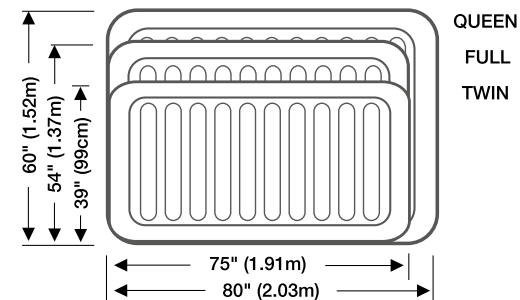

Comfort-Plush Horizontal Beam Airbed

- Quality tested waterproof flocked top and sides with vinyl bottom
- Fiber-Tech™ Technology
- Built-in electric pump
- Includes hand carry bag
- Folds compactly for storage or travel
- Air Lock® tested
- Shelf box

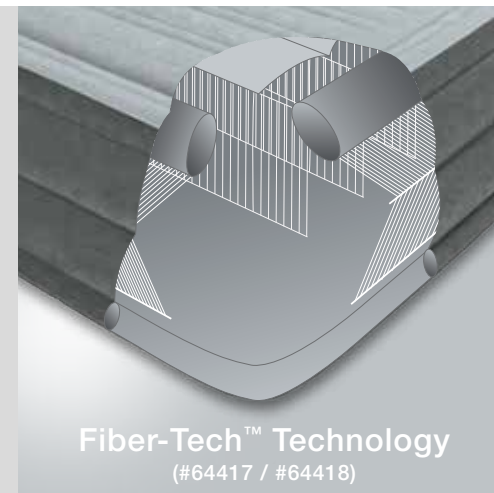
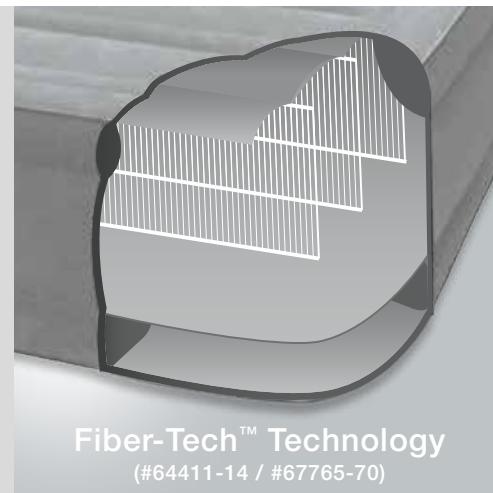

13"
(33cm)
BED HEIGHT

18"
(46cm)
BED HEIGHT

22"
(56cm)
BED HEIGHT

INFLATING TIMES*	Twin	2 minutes	Twin	2½ minutes	Queen	4½ minutes
AC Electric Pump	Full	3 minutes	Queen	4 minutes		
	Queen	3 minutes				

* Inflation time varies by mattress size and desired firmness

AIRBED WITH BUILT-IN ELECTRIC PUMP

Item	Size	Approximate Inflated Size	Built-in Pump	Case Pack	Case Weight
67765E 67766 / ES	Twin	39" x 75" x 13" (99cm x 1.91m x 33cm)	110-120V 220-240V	3 ea	39.8 lb (18.1 kg)
67767E 67768 / ES	Full	54" x 75" x 13" (1.37m x 1.91m x 33cm)	110-120V 220-240V	2 ea	32.4 lb (14.7 kg)
67769E 67770 / ES	Queen	60" x 80" x 13" (1.52m x 2.03m x 33cm)	110-120V 220-240V	2 ea	36.5 lb (16.6 kg)

Item	Size	Approximate Inflated Size	Built-in Pump	Case Pack	Case Weight
64411E 64412 / ES	Twin	39" x 75" x 18" (99cm x 1.91m x 46cm)	110-120V 220-240V	3 ea	44.0 lb (20.0 kg)
64413E 64414 / ES	Queen	60" x 80" x 18" (1.52m x 2.03m x 46cm)	110-120V 220-240V	2 ea	40.9 lb (18.6 kg)
64417E 64418 / ES	Queen	60" x 80" x 22" (1.52m x 2.03m x 56cm)	110-120V 220-240V	2 ea	46.7 lb (21.2 kg)

The patented Fiber-Tech™ inner construction utilizes thousands of high-strength polyester fibers that, unlike traditional airbed construction, do not stretch over time, resulting in amazing durability for years of lasting comfort.

Each bed is covered in plush flocking that is soft to the touch, and the horizontal air chambers provide added stability and support around the entire bed. For extra convenience, this bed comes with a powerful built-in electric pump for fast inflation and deflation.



PREMIUM COMFORT-PLUSH

WITH FIBER-TECH™ TECHNOLOGY

Our Premium Comfort-Plush raised airbed with built in pillow offers the perfect airbed for overnight guests or an upcoming family vacation. You won't want to leave home without it.

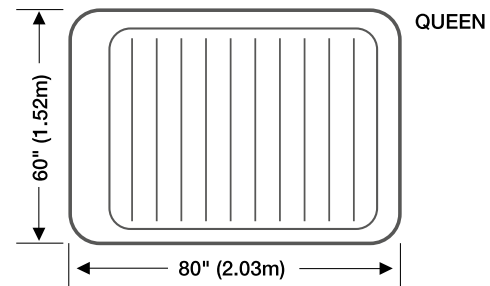

AIRBED WITH BUILT-IN ELECTRIC PUMP

Item	Size	Approximate Inflated Size	Built-in Pump	Case Pack	Case Weight
64403E	Queen	60" x 80" x 13"	110-120V	2 ea	33.8 lb (15.4 kg)
64404 / ES		(1.52m x 2.03m x 33cm)	220-240V		
64407E	Queen	60" x 80" x 18"	110-120V	2 ea	37.4 lb (17.0 kg)
64408 / ES		(1.52m x 2.03m x 46cm)	220-240V		



13" / 18"
(33cm / 46cm)

BED HEIGHT

RAISED DURA-BEAM® AIRBED WITH BUILT IN PILLOW

- Includes built-in Pillow Rest
- Fiber-Tech™ Technology
- Quality tested waterproof flocked top and sides with vinyl bottom
- Strong and lightweight
- Built-in electric pump
- Includes hand carry bag
- Folds compactly for storage or travel
- Air Lock® Tested
- Shelf box

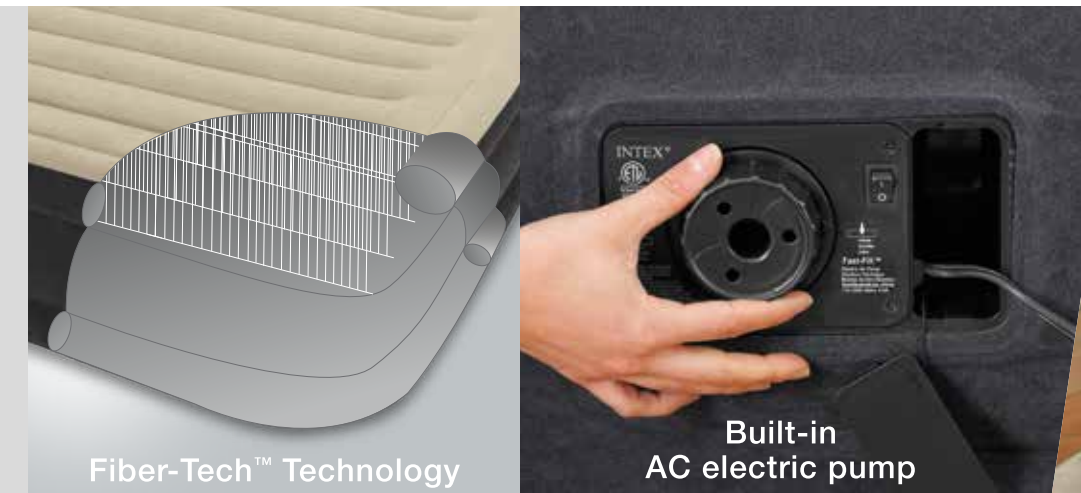

INFLATING TIMES*

AC Electric Pump

13" (33cm)	3½ minutes
18" (46cm)	4 minutes

* Inflating time varies by mattress size and desired firmness

Innovative Fiber-Tech™ Technology airbeds are comprised of thousands of high-strength polyester fibers. Unlike traditional airbed construction, these high-strength polyester fibers do not stretch over time, resulting in amazing durability for years of lasting comfort. Fiber-Tech™ interior construction provides the ideal firmness for superb support and rejuvenating sleep.

Each bed is covered in soft flocking for extra comfort and the horizontal air chambers provide added stability and support around the entire bed. The bed's built-in pillow makes it ideal for everyday indoor and outdoor use. For extra convenience, this bed comes with a powerful built-in electric pump for fast inflation and deflation.



REDEFINING THE AIRBED

INTRODUCING

PremAire™

Elevated Series
with Fiber-Tech™ Technology

Intex is proud to bring you a new level of luxury and innovation with the latest edition to our unrivaled airbed line, the PremAire™ Elevated Series with Fiber-Tech™ Technology.

Built with our patented Fiber-Tech™ Technology, our PremAire™ beds offer superb structural stability and support. The high-strength fibers provide an interior with amazing durability and unmatched comfort. The exterior of the mattress is made of laminated PVC to provide a high quality puncture resistant surface. Each mattress is covered in a pillow top that creates air pockets that cause air to flow smoothly and gradually across the surface for an unparalleled sleeping experience.

The bed's elevated height makes it easier to get in and out of each morning. For extra convenience, this bed comes with a powerful built-in electric pump for fast inflation and deflation. Our new revolutionary PremAire™ mattress offers the perfect combination of luxurious comfort and best-in-class durability.

INTEX®

INTEX®

PremAire™
WITH FIBER-TECH™ TECHNOLOGY

THE MOST ADVANCED AIRBED TECHNOLOGY

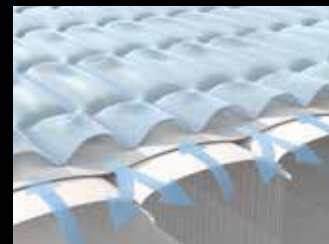

LUXURIOUS PILLOW TOP

Hundreds of inter-connected air pockets engineered so that air flows gently across the sleeping surface creating body-hugging comfort

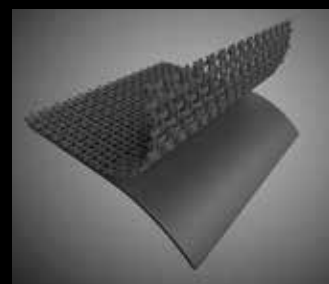

HEAVY DUTY 2-PLY MATERIAL

The 2-ply laminated side walls and bottom firmly retain air while providing a high quality puncture-resistant surface



100% QUALITY TESTED

100% of our airbeds are quality tested to be air tight before they leave our factory

POWERFUL BUILT-IN AIR PUMP

Powerful built-in electric pump for fast inflation and deflation

QUALITY ASSURED

1 YEAR
LIMITED WARRANTY

Peace of mind
1 year warranty



18"
(46cm)
BED HEIGHT

NEWLY REDESIGNED CARRY BAG

New stylish carry bag for easy storage and transport

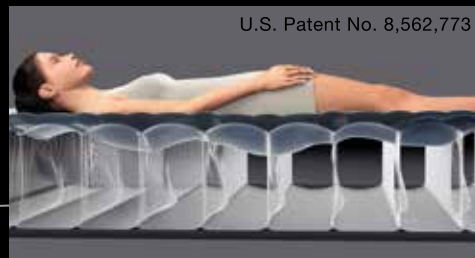

U.S. Patent No. 8,562,773

REVOLUTIONARY FIBER-TECH™ TECHNOLOGY

Revolutionary, patented Fiber-Tech™ support system provides the perfect combination of superb structural stability and support

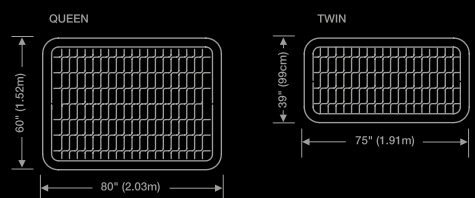

Item	Size	Approximate Inflated Size	Built-in Pump	Case Pack	Case Weight
64471E 64472 / ES	Twin	39" x 75" x 18" (99cm x 1.91m x 46cm)	110-120V 220-240V	2 ea	32.1 lb (14.6 kg)
64473E 64474 / ES	Queen	60" x 80" x 18" (1.52m x 2.03m x 46cm)	110-120V 220-240V	1 ea	22.6 lb (10.3 kg)

INFLATING TIMES*

AC Electric Pump

Twin	2½ minutes
Queen	4 minutes

*Inflating time varies by mattress size and desired firmness



THE PERFECT COMBINATION OF COMFORT AND SUPPORT



Enjoy the Great Outdoors

Intex knows that disconnecting from the pace of modern life doesn't mean giving up comfort. Intex Camping Airbeds have all been specifically designed to provide an uncompromising level of style, durability, comfort, and ease. Intex Camping Airbeds come in a variety of shapes, sizes, and styles to suit nearly any outdoor adventure.

CAMPING MATS

A quick, simple and lightweight sleeping solution while camping. Wave beam construction for a uniform sleeping surface. Intex camping mats provide comfort and durability for outside conditions.

LAMINATED FABRIC TOPS FOR DURABILITY

- Laminated vinyl to withstand the elements
- Each mat has a unique construction that helps provide more comfort to campers
- Folds compactly for easy storage or travel
- Topped with fabric to ensure sleeping comfort
- Shelf box

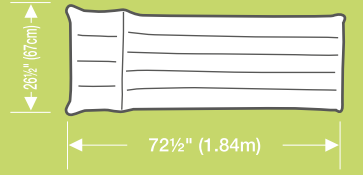
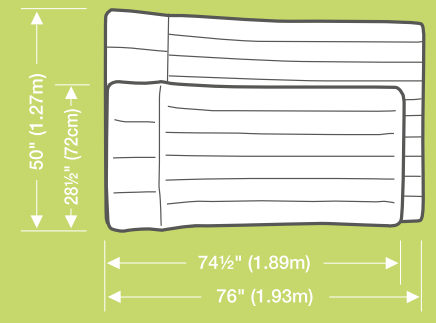

#68797



#68799



#68798

CAMPING MAT

Item	Approximate Inflated Size	Case Pack	Case Weight
68797 / E	26½" x 72½" x 6¾" (67cm x 1.84m x 17cm)	6 ea	19.1 lb (8.7 kg)
68798 / E	28½" x 74½" x 8" (72cm x 1.89m x 20cm)	6 ea	26.0 lb (11.8 kg)
68799 / E	50" x 76" x 9½" (1.27m x 1.93m x 24cm)	3 ea	22.6 lb (10.3 kg)

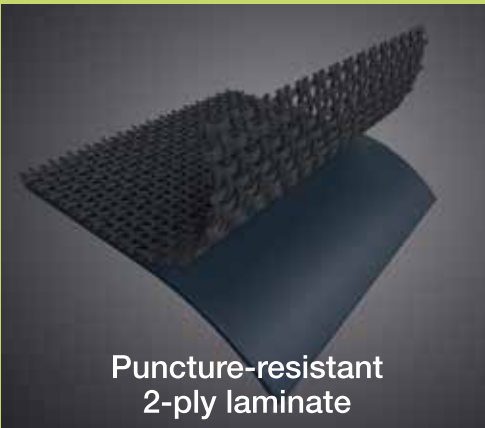

Puncture-resistant 2-ply laminate

DOWNY BED

This airbed has a flocked top that provides a more comfortable sleeping surface. Its unique wave beam construction eliminates uncomfortable surface bumps and provides a flat, uniform sleeping surface. The Downy airbed can be inflated with either the built-in manual foot pump or a regular pump.

BUILT-IN FOOT PUMP FOR CONVENIENCE

- Unique built-in bellow foot pump for convenience-no separate pump needed. Just step down to inflate and the pump springs back automatically for the next cycle
- New and improved foot pump construction allows for faster inflation
- 2-in-1 valve for inflating with optional electric or manual pumps
- Conventional mattress sizes (L x W) for more sleeping area and a better fit for sheets
- 8¾" (22cm) mattress thickness for extra soft comfort
- Shelf box

AIRBED WITH BUILT-IN FOOT PUMP

Item	Size	Approximate Inflated Size	Case Pack	Case Weight
66950 / E	JR. Twin	30" x 75" x 8¾" (76cm x 1.91m x 22cm)	6 ea	36.4 lb (16.6 kg)
66927 / E	Twin	39" x 75" x 8¾" (99cm x 1.91m x 22cm)	4 ea	29.8 lb (13.5 kg)
66928 / E	Full	54" x 75" x 8¾" (1.37m x 1.91m x 22cm)	3 ea	28.3 lb (12.9 kg)
66929 / E	Queen	60" x 80" x 8¾" (1.52m x 2.03m x 22cm)	3 ea	32.3 lb (14.7 kg)

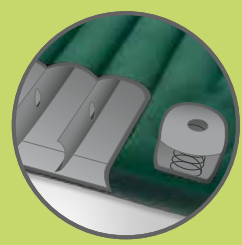

Wave Beam Construction
U.S. Patent No. D414,644



Built-in lightweight foot pump for easy inflation - No separate pump or power supply needed!

INFLATING TIMES*

Jr. Twin	2 minutes
Twin	2 minutes
Full	3 minutes
Queen	4 minutes

* Inflating time varies by mattress size and desired firmness

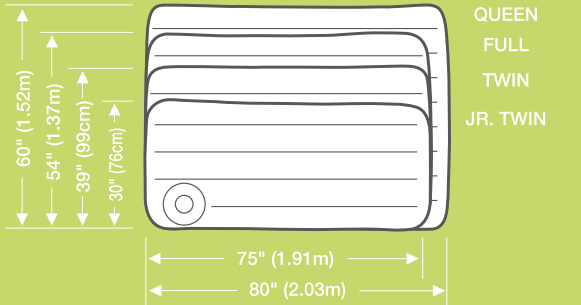

PRESTIGE DOWNY BED

AIRBED WITH SEPARATE BATTERY PUMP (6 X C-CELL)

Item	Size	Approximate Inflated Size	Case Pack	Case Weight
66967 / E	Twin	39" x 75" x 8¾" (99cm x 1.91m x 22cm)	4 ea	30.4 lb (13.8 kg)
66968 / E	Full	54" x 75" x 8¾" (1.37m x 1.91m x 22cm)	3 ea	29.0 lb (13.2 kg)
66969 / E	Queen	60" x 80" x 8¾" (1.52m x 2.03m x 22cm)	3 ea	33.4 lb (15.2 kg)



INFLATING TIMES*

Twin	2 minutes
Full	2 minutes
Queen	2½ minutes

* Inflating time varies by mattress size and desired firmness

The perfect choice for the rugged outdoors. The flopped top provides a comfortable sleeping surface, cleans easily and is waterproof for camping. The powerful battery-operated (6 x C-cell) pump goes anywhere!

WITH HAND-HELD BATTERY PUMP

- 3-in-1 valve has extra-wide openings for fast inflating and deflating
- Conventional mattress sizes (L x W) for more sleeping area and a better fit for sheets
- Battery pump can also be used on other inflatables
- 8¾" (22cm) mattress thickness for extra soft comfort
- Folds compactly for storage or travel
- Shelf box

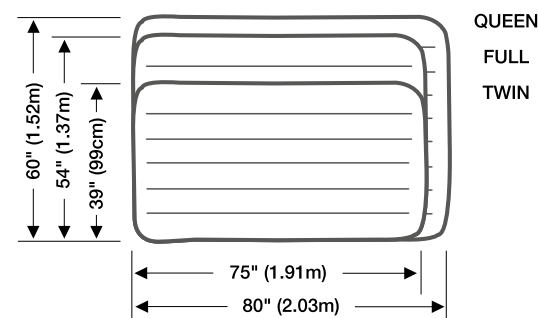

CLASSIC DOWNY BED

For indoor and outdoor use.

AIRBED ONLY

Item	Size	Approximate Inflated Size	Case Pack	Case Weight
68950 / E	JR. Twin	30" x 75" x 8¾" (76cm x 1.91m x 22cm)	6 ea	31.2 lb (14.2 kg)
68757 / E	Twin	39" x 75" x 8¾" (99cm x 1.91m x 22cm)	4 ea	26.1 lb (11.9 kg)
68758 / E	Full	54" x 75" x 8¾" (1.37m x 1.91m x 22cm)	3 ea	25.9 lb (11.8 kg)
68759 / E	Queen	60" x 80" x 8¾" (1.52m x 2.03m x 22cm)	3 ea	30.6 lb (13.9 kg)
68755 / E	King	72" x 80" x 8¾" (1.83m x 2.03m x 22cm)	2 ea	23.9 lb (10.9 kg)

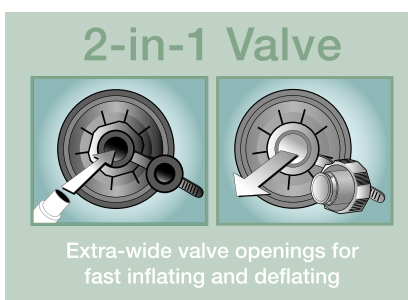
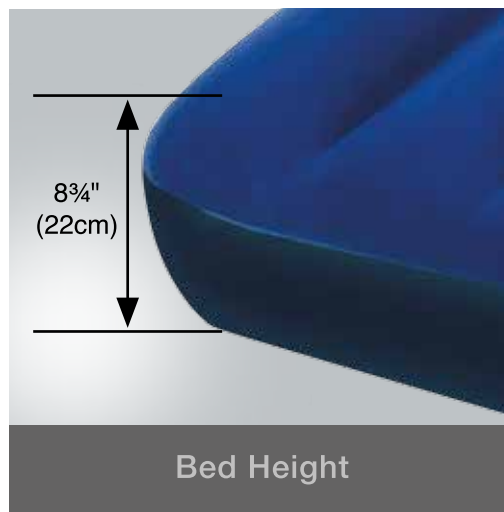

AIRBED SET

Includes two I-beam pillows 17" x 11" x 3½" (43cm x 28cm x 9cm) and a #68612 Double-Quick air pump

Item	Size	Approximate Inflated Size	Hand Pump	Case Pack	Case Weight
68765 / E	Queen	60" x 80" x 8¾" (1.52m x 2.03m x 22cm)	68612	3 ea	35.0 lb (15.9 kg)

You can't go wrong with this bed! Take it camping or use it for out of town guests. Our best selling Classic Downy Bed is versatile and perfect for both in-home and camping. The wave beam construction creates a uniform sleeping surface that is guaranteed to give you a good night's rest wherever you are. Plush flocking provides a luxurious sleeping surface while keeping sheets in place. It's also easy to clean and waterproofed for camping use. The Classic Downy Bed offers retailers and consumers the best value for their money at an opening price point.

PLUSH FLOCKED TOP FOR COMFORT

- 2-in-1 valve has extra-wide openings for fast inflating and deflating
- Conventional mattress sizes (L x W) for more sleeping area and a better fit for sheets
- 8¾" (22cm) mattress thickness for extra soft comfort
- Folds compactly for storage or travel
- Shelf box

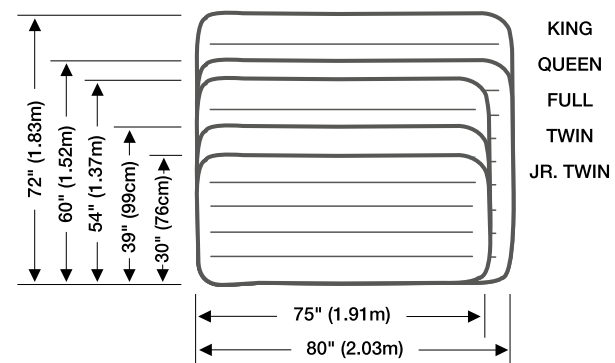

Sleep Tight. Travel Light.

With all of the demands of modern life, travel, whether for work or personal, has become a necessity. Intex Single Airbeds allow the modern traveler a way of taking a little bit of home with them in a compact and comfortable airbed. Let Intex make you feel at home.



PILLOW REST CLASSIC BED

AIRBED ONLY

Item	Size	Approximate Inflated Size	Case Pack	Case Weight
66767 / E	Twin	39" x 75" x 9" (99cm x 1.91m x 23cm)	4 ea	28.4 lb (12.9 kg)
66768 / E	Full	54" x 75" x 9" (1.37m x 1.91m x 23cm)	3 ea	28.4 lb (12.9 kg)
66769 / E	Queen	60" x 80" x 9" (1.52m x 2.03m x 23cm)	3 ea	33.8 lb (15.4 kg)
66770 / E	King	72" x 80" x 9" (1.83m x 2.03m x 23cm)	2 ea	27.0 lb (12.3 kg)

BUILT-IN COMFORT

- Flocked sleeping surface for extra comfort
- A built-in pillow provides bed-like comfort
- Mattress is raised 9" (23cm) from the floor for convenience
- 3-in-1 valve on "Airbed Only" series has extra-wide openings
- Inflated dimensions fit standard sheet sizes
- Includes carry bag
- Shelf box



Wave Beam Construction
U.S. Patent No. D414,644



Built-in
AC Electric Pump

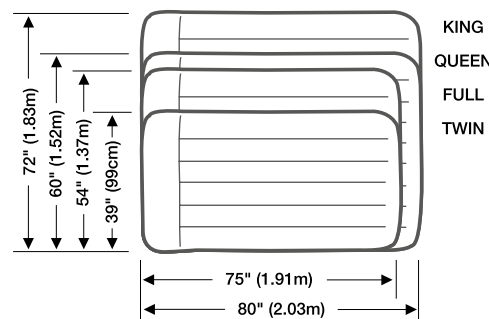

Built-in pillow for
added convenience

For those who need a pillow but lack the space to carry one, this luxurious flocked bed is the answer. The waterproof and stain resistant surface makes it easy to keep clean while providing the soft comfort of home.

AIRBED WITH BUILT-IN ELECTRIC PUMP

Item	Size	Approximate Inflated Size	Built-in Pump	Case Pack	Case Weight
66775E 66779	Twin	39" x 75" x 9" (99cm x 1.91m x 23cm)	110-120V 220-240V	4 ea	36.8 lb (16.7 kg)
66776E 66780	Full	54" x 75" x 9" (1.37m x 1.91m x 23cm)	110-120V 220-240V	3 ea	34.7 lb (15.8 kg)
66777E 66781	Queen	60" x 80" x 9" (1.52m x 2.03m x 23cm)	110-120V 220-240V	3 ea	41.4 lb (18.8 kg)

INFLATING TIMES*

AC Electric Pump	
Twin	1 minute
Full	1½ minutes
Queen	1¾ minutes

* Inflating time varies by mattress size and desired firmness

ELEVATED FOR CONVENIENCE

- Flocked sleeping surface for extra comfort
- A built-in pillow provides bed-like comfort
- Mattress is raised 13¾" (35cm) from the floor for convenience
- Inflated dimensions fit standard sheet sizes
- Includes hand carry bag
- Shelf box

INFLATING TIMES*

AC Electric Pump	
Twin	1¾ minutes
Queen	3 minutes

* Inflating time varies by mattress size and desired firmness



Built-in pillow for
added convenience

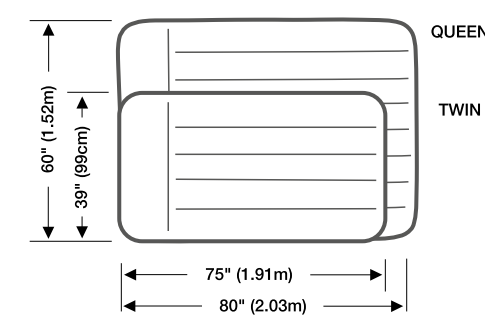

I-Beam Construction

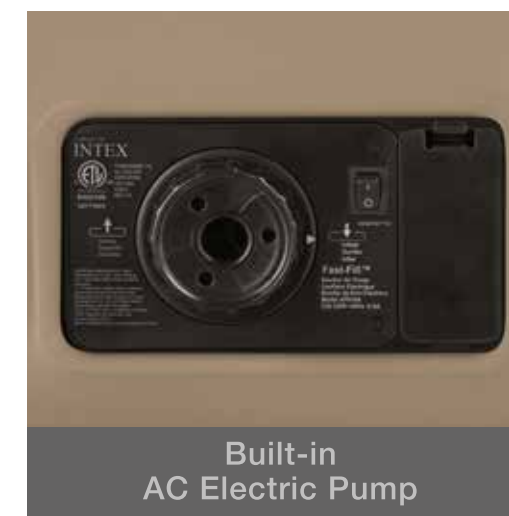

Built-in
AC Electric Pump

PILLOW REST MID-RISE BED

AIRBED WITH BUILT-IN ELECTRIC PUMP

Item	Size	Approximate Inflated Size	Built-in Pump	Case Pack	Case Weight
67741E 67742	Twin	39" x 75" x 13¾" (99cm x 1.91m x 35cm)	110-120V 220-240V	3 ea	32.2 lb (14.6 kg)
67747E 67748	Queen	60" x 80" x 13¾" (1.52m x 2.03m x 35cm)	110-120V 220-240V	2 ea	31.9 lb (14.5 kg)

Our mid-rise airbed provides all of the great benefits of our high-rise airbed, but with the added advantage of lighter weight and easier portability. The bed features a contoured bottom which provides a better gripping effect to increase stability. Perfect for travelers who are looking for all of the comforts of a raised bed, plus the convenience of easy transportation. Twin size is also available.



PILLOW REST RAISED BED

AIRBED ONLY

Item	Size	Approximate Inflated Size	Case Pack	Case Weight
66721 / E	Twin	39" x 75" x 16½" (99cm x 1.91m x 42cm)	3 ea	32.8 lb (14.9 kg)
66720 / E	Queen	60" x 80" x 16½" (1.52m x 2.03m x 42cm)	2 ea	35.2 lb (16.0 kg)

ELEVATED FOR CONVENIENCE

- Mattress is raised 16½" (42cm) from the floor for convenience
- 3-in-1 valve on "Airbed Only" series has extra-wide openings
- A built-in pillow provides bed-like comfort
- Includes hand carry bag
- Shelf box



**16½"
(42cm)
BED HEIGHT**



Wave Beam Construction
U.S. Patent No. D414,644



Built-in
AC Electric Pump

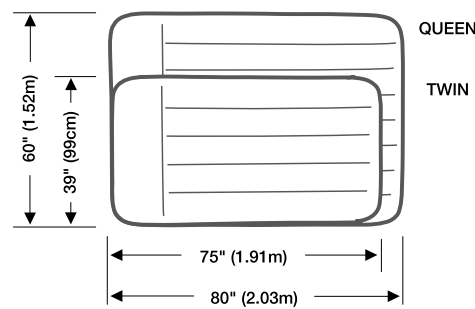

Built-in pillow for
added convenience

The Pillow Rest Raised Bed is our best selling raised airbed. By providing all of the great benefits of a raised bed and built-in pump, this bed is perfect for house guests, dorm rooms and even camping trips! It's light, convenient and with a built-in pillow, it's as comfortable as your bed at home. This bed is truly a great value at a great price.

INFLATING TIMES*

AC Electric Pump

Twin	2½ minutes
Queen	4 minutes

* Inflating time varies by mattress size and desired firmness

AIRBED WITH BUILT-IN ELECTRIC PUMP

Item	Size	Approximate Inflated Size	Built-in Pump	Case Pack	Case Weight
66705E 66706	Twin	39" x 75" x 16½" (99cm x 1.91m x 42cm)	110-120V 220-240V	3 ea	40.5 lb (18.4 kg)
67701E 66702	Queen	60" x 80" x 16½" (1.52m x 2.03m x 42cm)	110-120V 220-240V	2 ea	40.2 lb (18.3 kg)

BUILT-IN PILLOW AND SOFT FLOCKED TOP FOR COMFORT

- 3-in-1 valve on "Airbed Only" series has extra-wide openings for fast inflating and deflating
- Mattress is raised 16¾" (43cm) from the floor for convenience
- Indented sides to better grip standard size sheets
- Includes hand carry bag
- Shelf box

INFLATING TIMES*

AC Electric Pump

Twin	2 minutes
Queen	3½ minutes

* Inflating time varies by mattress size and desired firmness

AIRBED WITH BUILT-IN ELECTRIC PUMP

Item	Size	Approximate Inflated Size	Built-in Pump	Case Pack	Case Weight
67731E 67732	Twin	39" x 75" x 16¾" (99cm x 1.91m x 43cm)	110-120V 220-240V	3 ea	39.4 lb (17.9 kg)
67737E 67738	Queen	60" x 80" x 16¾" (1.52m x 2.03m x 43cm)	110-120V 220-240V	2 ea	37.5 lb (17.1 kg)



Built-in pillow for
added convenience

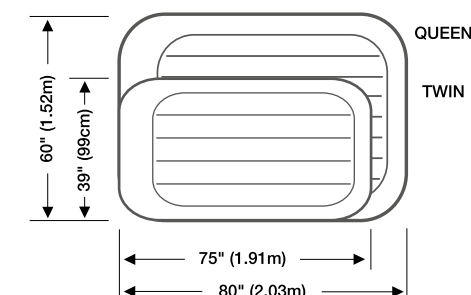

Deluxe Pillow Rest
Construction



Built-in
AC Electric Pump

DELUXE PILLOW REST RAISED BED

AIRBED ONLY

Item	Size	Approximate Inflated Size	Case Pack	Case Weight
67736 / E	Queen	60" x 80" x 16¾" (1.52m x 2.03m x 43cm)	2 ea	33.0 lb (15.0 kg)

A deluxe version of our best selling Pillow Rest Raised Bed! This style features an outer perimeter frame on the sleeping surface that provides added stability. This outer frame prevents your guests from accidentally rolling off – especially useful when the bed sleeps two! The two-tone color is pleasing to the eye and the soft plush flocking of the built-in pillow makes this bed a premium sleeping experience.



**16¾"
(43cm)
BED HEIGHT**

RAISED DOWNY BED

AIRBED WITH BUILT-IN ELECTRIC PUMP

Item	Size	Approximate Inflated Size	Built-in Pump	Case Pack	Case Weight
66717E 66718	Queen	60" x 80" x 22" (1.52m x 2.03m x 56cm)	110-120V 220-240V	2 ea	46.7 lb (21.2 kg)

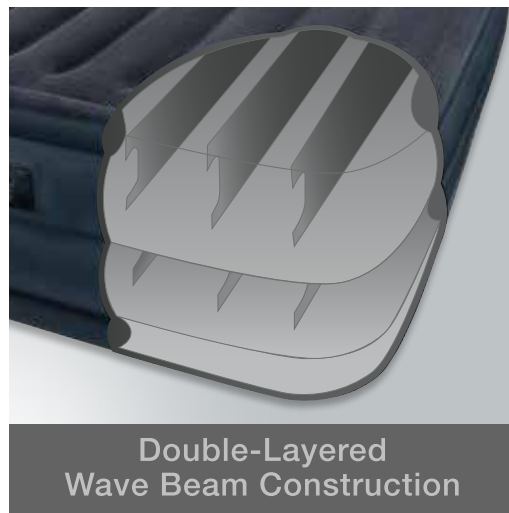

Double-Layered Wave Beam Construction



Built-in AC Electric Pump



INFLATING TIMES*	
AC Electric Pump	
110V-120V	5 minutes
220V-240V	5 minutes

* Inflating time varies by mattress size and desired firmness



22" (56cm) BED HEIGHT

Our Raised Downy Bed is the perfect bed for consumers who are used to sleeping on raised surfaces. Your house guests will love the support and firmness created by the dual chamber construction. Indented sides help grip fitted sheets. The outer perimeter frame on both top and bottom provides additional stability and support making this bed the ultimate Comfort Rest™ experience.

ELEVATED FOR COMFORT & CONVENIENCE

- Dual-chamber construction. The lower chamber functions as the box spring form on a traditional bed, providing extra firmness and support. The upper chamber functions as a mattress
- 60" x 80" (1.52m x 2.03m) queen-sized mattress is raised 22" (56cm) from the floor for convenience
- Cozy flopped mattress top
- Deflates completely for travel and storage
- Includes hand carry bag
- Shelf box

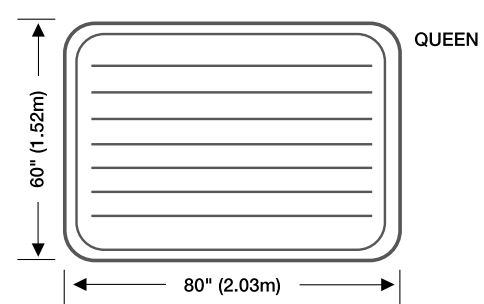

PREMIUM

Luxurious Comfort. Innovative Design.

Enjoy a luxurious night's sleep with an Intex Premium Airbed. Each airbed in our Premium line has been engineered and tested to provide you with a restful sleeping experience that rivals a traditional mattress. Plush Velvetaire™ flocking, interconnected air pocket system, luxurious foam – Intex Premium airbeds combine the best features with superior functionality that guarantee to provide you with the ultimate sleeping experience.



ULTRA PLUSH BED

AIRBED WITH BUILT-IN ELECTRIC PUMP

Item	Size	Approximate Inflated Size	Built-in Pump	Case Pack	Case Weight
67951E 67952	Twin	39" x 75" x 18" (99cm x 1.91m x 46cm)	110 - 120V 220 - 240V	2 ea	35.0 lb (15.9 kg)
66957E 66958	Queen	60" x 80" x 18" (1.52m x 2.03m x 46cm)	110 - 120V 220 - 240V	2 ea	51.2 lb (23.3 kg)

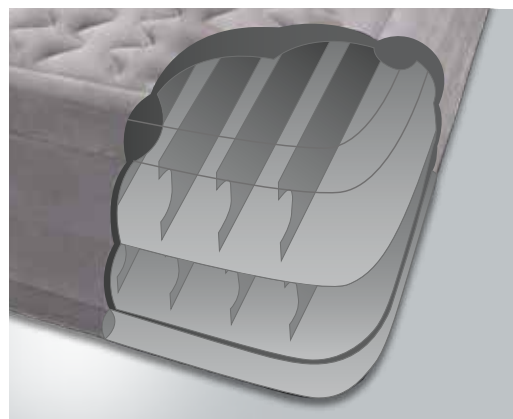

Double-Layered I-Beam Construction
U.S. Patent No. 6,568,011



Built-in AC Electric Pump



Here's an airbed that is sure to impress your most important guests: Intex's Ultra Plush Airbed. This raised bed combines comfort, convenience, and great appearance into one luxurious airbed, with its unique textured sleeping surface and inflated outer perimeter band for extra stability. Great for guests – but you might just want to keep it for family members!

ELEVATED WITH BUILT-IN ELECTRIC PUMP

- Flocked sleeping surface and sides for comfort and appearance
- Inflated bed fits standard sheets
- Bottom of the bed is contoured to provide extra gripping effect to increase stability
- Built-in electric pump for quick inflation and deflation
- Includes hand carry bag
- Shelf box



18"
(46cm)
BED HEIGHT



INFLATING TIMES*	
AC Electric Pump	
Twin	2½ minutes
Queen	4 minutes

* Inflation time varies by desired firmness

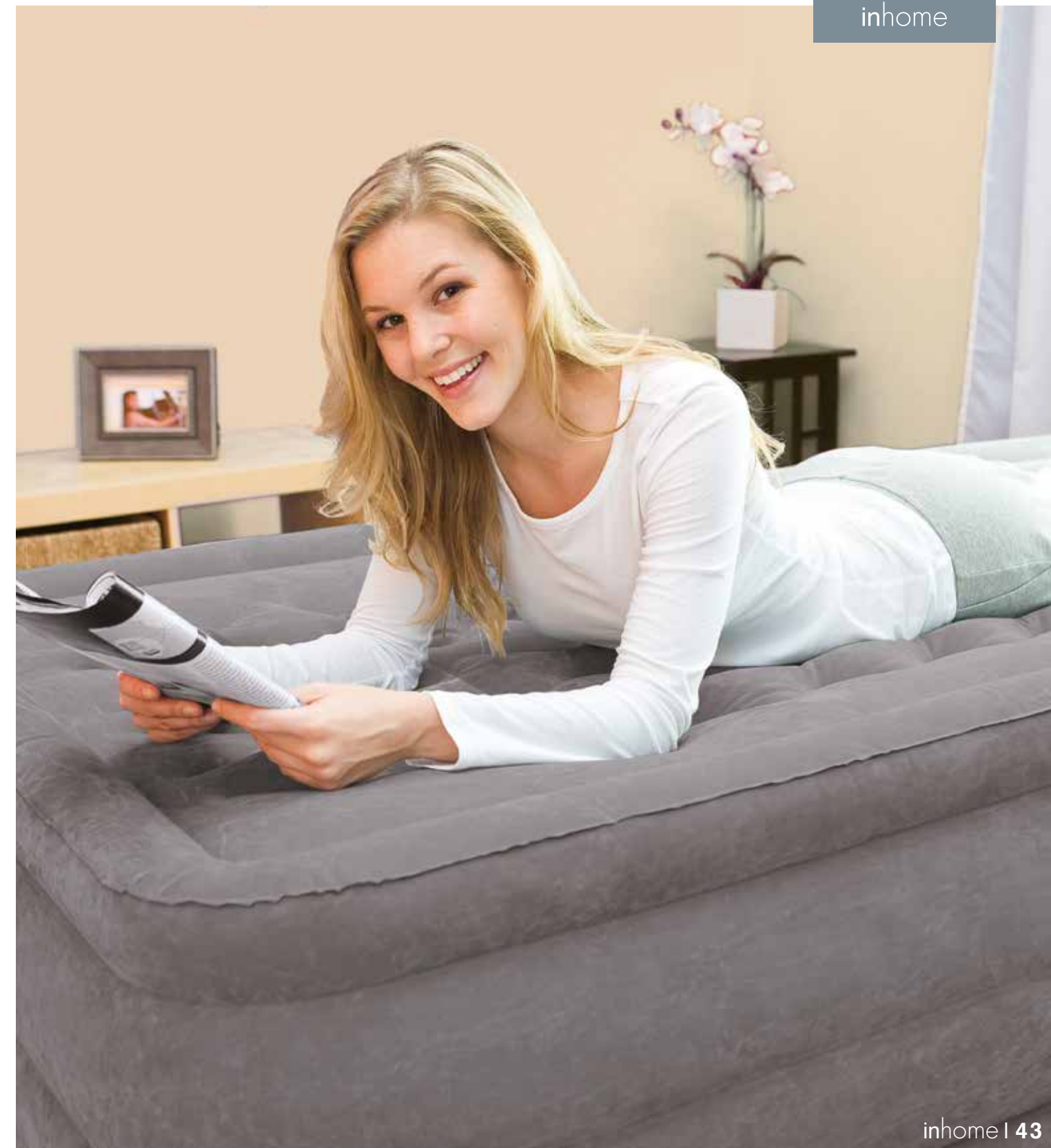
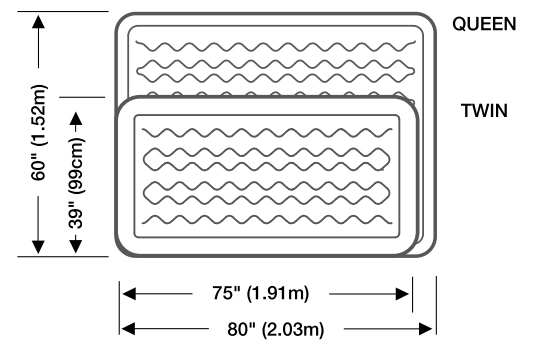

SUPREME AIR-FLOW BED

AIRBED WITH BUILT-IN ELECTRIC PUMP

Item	Size	Approximate Inflated Size	Built-in Pump	Case Pack	Case Weight
66963E 66964	Twin	39" x 75" x 20" (99cm x 1.91m x 51cm)	110 - 120V 220 - 240V	2 ea	50.4 lb (22.9 kg)
66961E 66962	Queen	60" x 80" x 20" (1.52m x 2.03m x 51cm)	110 - 120V 220 - 240V	1 ea	35.4 lb (16.1 kg)

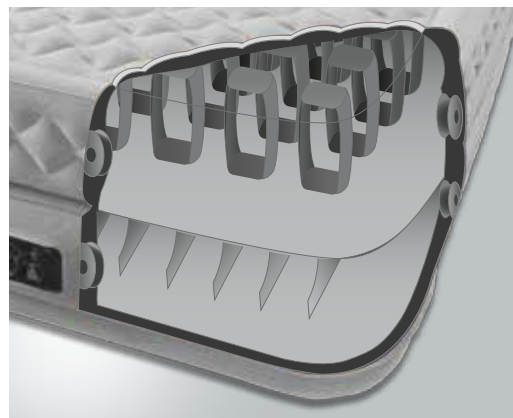

Coil-Beam/I-Beam Hybrid Construction
U.S. Patent No. 7,636,970



Built-in AC Electric Pump



20"
(51cm)
BED HEIGHT

INFLATING TIMES*

AC Electric Pump	
Twin	2½ minutes
Queen	4 minutes

* Inflation time varies by mattress size and desired firmness

Our top of the line Supreme Air Flow Bed is engineered to provide the ultimate comfort with the look and feel of a real high end bed! A network of inter-connected air pockets on the top and sides of the bed cause the air to flow smoothly and gradually across the sleeping surface for unbelievable comfort and stability. The dual chamber construction provides firm support and allows for fitted sheets to tuck in easily. Topped with super soft Velvetaire™ flocking, this bed rivals a traditional mattress, providing a premium sleeping experience.

ELEVATED WITH BUILT-IN ELECTRIC PUMP

- Dual chamber construction consists of I-beams in bottom chamber and coil beams in upper chamber that is surrounded on top and sides with a layer of inter-connected air cells to ensure gradual, smooth airflow across the entire surface of the bed
- Mattress is raised 20" (51cm) from the floor for convenience
- Mattress quickly and easily inflates and deflates with a high-powered built-in electric pump
- Cozy flocked fabric mattress that allows for sheets to be easily tucked in
- Includes hand carry bag
- Shelf box

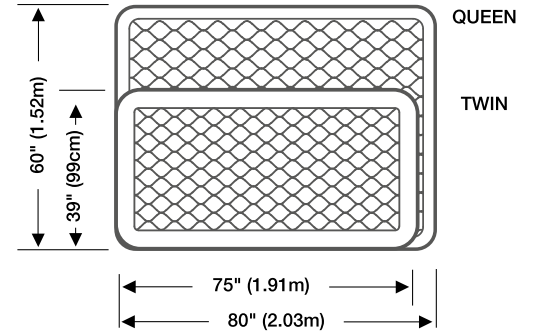

FOAM TOP BED

AIRBED WITH BUILT-IN ELECTRIC PUMP

Item	Size	Approximate Inflated Size	Built-in Pump	Case Pack	Case Weight
67953E	Queen	60" x 80" x 20"	110 - 120V	1 ea	31.8 lb (14.5 kg)
67954		(1.52m x 2.03m x 51cm)	220 - 240V		30.7 lb (14.0 kg)

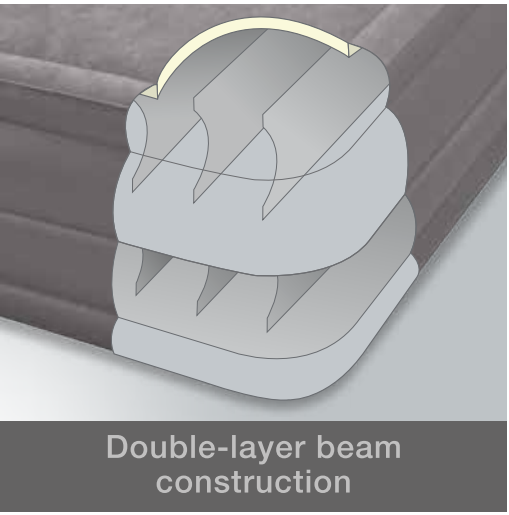

Double-layer beam construction



Built-in AC Electric Pump



20"
(51cm)

BED HEIGHT



Enjoy a luxurious night's sleep in our Foam Top High-Rise bed. Its foam sleeping surface comfortably contours to your body and provides added warmth for a rejuvenating sleep experience. The bed is covered in plush Velvetaire™ flocking that is soft to the touch and the bed's elevated height makes it easier to get in and out of, much like a traditional mattress. For fast and easy inflation & deflation the bed comes with a powerful built-in electric pump.

ELEVATED WITH BUILT-IN ELECTRIC PUMP

- Foam Top layer
- Plush Velvetaire™ flocked sleeping surface
- Double layered I-beam construction
- Built-in electric pump
- Includes hand carry bag
- Folds compactly for storage or travel
- Shelf box

INFLATING TIMES*

AC Electric Pump	
110-120V	4 minutes
220-240V	4 minutes

* Inflating time varies by desired firmness

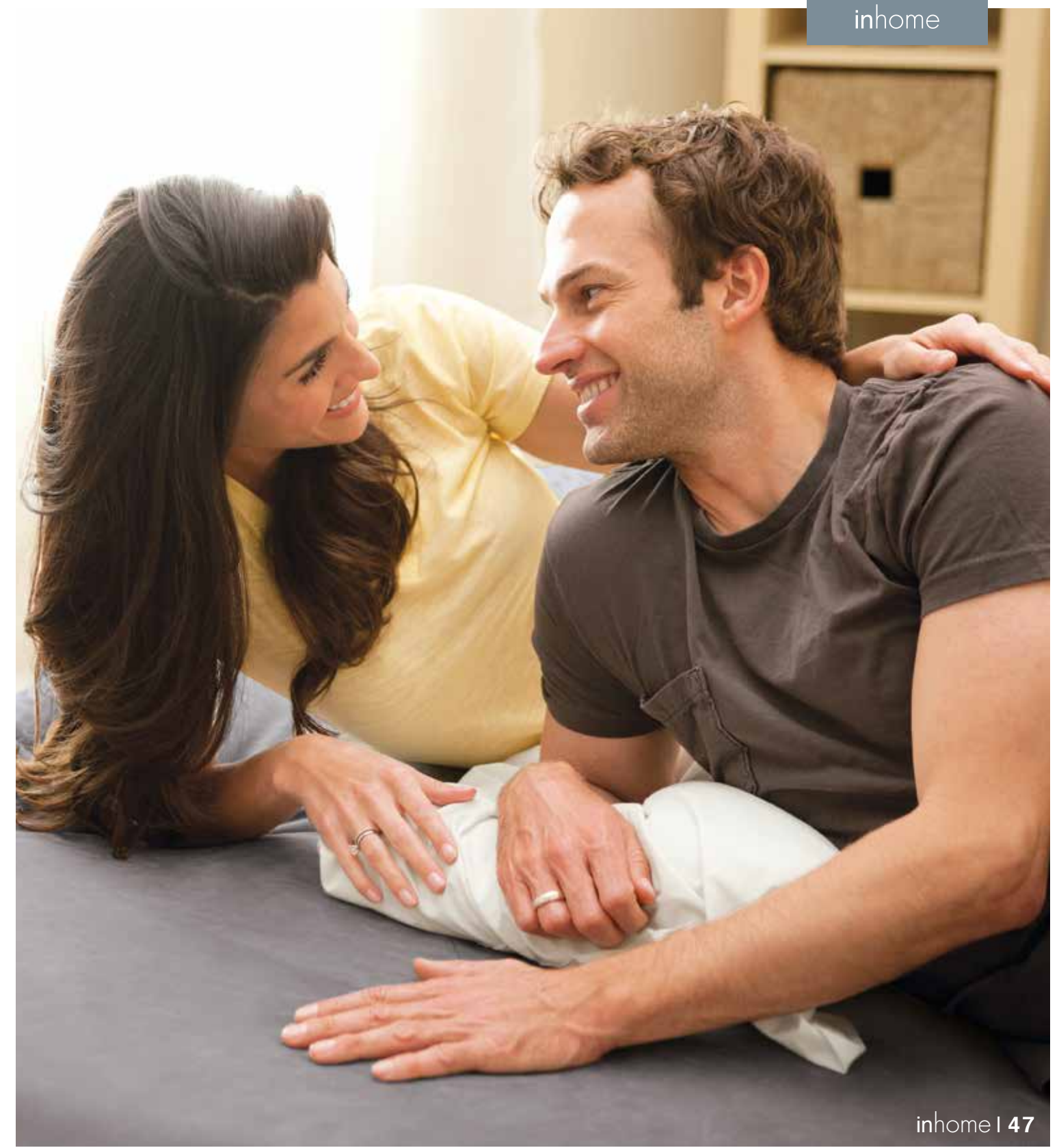
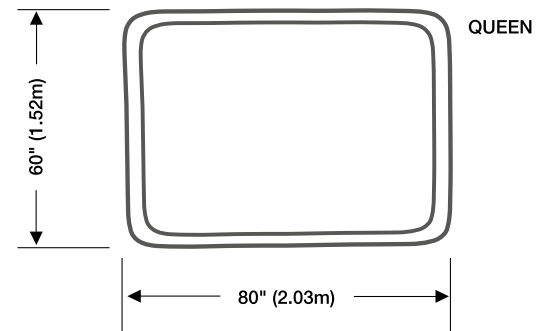



AIR FURNITURE

Light. Bright. Fun. Something For Everyone.

Intex brings to you an exciting and vibrant line of air furniture for any age, any setting and any season! With great colors and design, whether for the indoors or the outdoors, Intex has something for everyone. Decorate your room with Intex!



BEANLESS BAG™ CHAIR ASSORTMENT



A great bean bag without the hassle of bean bag inserts and slipcovers. Just unfold and inflate, and in minutes you have a super soft bean bag that is perfect for lounging, studying, or watching movies. Vivid colors will brighten up any room. Comes in an assortment of three bright and vivid colors: Magenta Pink, Lime Green, or Lilac Purple.

PERFECTLY PORTABLE BEANLESS BAG™

- Available in magenta pink, lime green and lilac purple
- Folds compactly for storage
- Shelf box

Item	Approximate Inflated Size	Case Pack	Case Weight
68569NP / EP	42" x 41" x 27" (1.07m x 1.04m x 69cm)	6 ea, asst	33.2 lb (15.1 kg)



Our plush Café Chair™ is the coolest seat in the house. With an innovative structure that gives you the comfort of a beanbag and the support of your favorite chair, the Café Chair™ is as comfortable as it is unique. Whether you are reading, watching TV, or relaxing, this is perfect! Comes in an assortment of three bright and vivid colors: Magenta Pink, Lime Green, or Lilac Purple.

FOR EXTENDED SEATING

- One large specially engineered seating cushion for serious pampering
- One small detachable backrest cushion for show and comfort
- Available in magenta pink, lime green and lilac purple
- Folds compactly for storage
- Shelf box

Item	Approximate Inflated Size	Case Pack	Case Weight
68563NP / EP	36" x 40" x 25½" (91cm x 1.02m x 65cm)	3 ea, asst	22.4 lb (10.2 kg)

CAFÉ CHAIR™





CAFÉ CLUB CHAIR

Easy comfort in splashy colors is the only way to describe our Café Club Chairs. Great for reading, gaming, or just chatting with friends, these chairs will bring life to any apartment or college dorm!

AN INVITING SPLASH OF COLOR AND COMFORT

- Available in magenta pink, lime green and sunny orange
- Folds compactly for storage
- Shelf box

Item	Approximate Inflated Size	Case Pack	Case Weight
68571NP / EP	38" x 30" x 27" (97cm x 76cm x 69cm)	3 ea, asst	21.3 lb (9.7 kg)



Stunning and eye-catching, this Café Chaise Chair adds flair to any room! Paired with an ottoman, the advanced structural design provides an exceptionally comfortable seat regardless of your height.

COLORFUL CUSHY LUXURY

- Combo valve has extra-wide openings for fast inflating and deflating
- Available in lilac purple, sky blue, and sunny orange
- Folds compactly for storage
- Shelf box

Item		Approximate Inflated Size	Case Pack	Case Weight
68572NP / EP	Chair	41" x 43" x 28" (1.04m x 1.09m x 71cm)	3 ea, asst	20.9 lb (9.5 kg)
	Ottoman	25" x 11" (64cm x 28cm)		

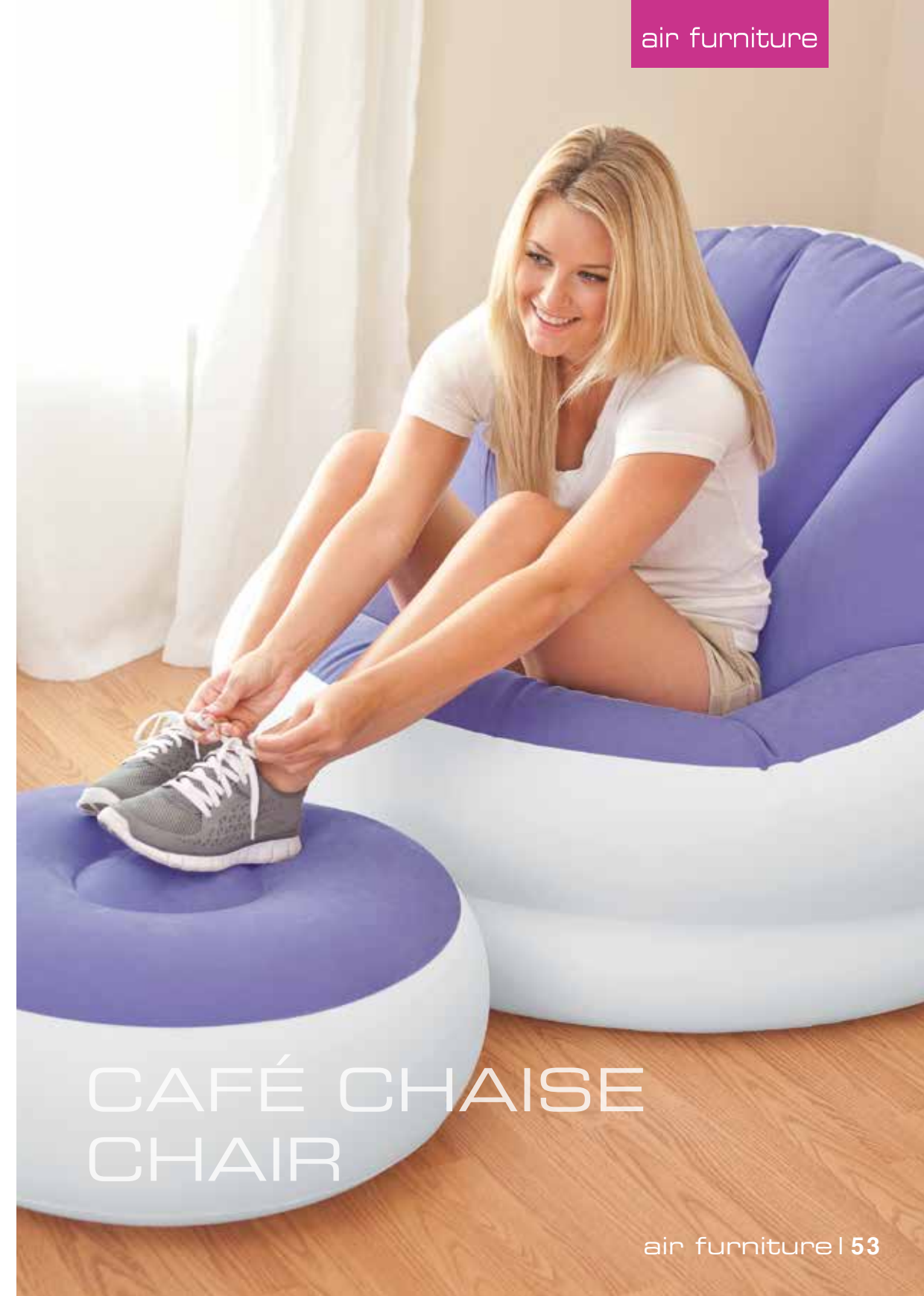

CAFÉ CHAISE CHAIR

BEANLESS BAG™ CHAIR



Intex completes the Beanless Bag™ Chair line with the introduction of a warm, neutral color combined with our revolutionary corduroy texture flocking! Its elegant and luxurious look and feel will add a new dimension to any room!

PERFECTLY PORTABLE BEANLESS BAG™

- Folds compactly for storage
- Shelf box



Item	Approximate Inflated Size	Case Pack	Case Weight
68579NP / EP	42" x 41" x 27" (1.07m x 1.04m x 69cm)	6 ea	34.1 lb (15.5 kg)



Revolutionary textured flocking feels like real corduroy!

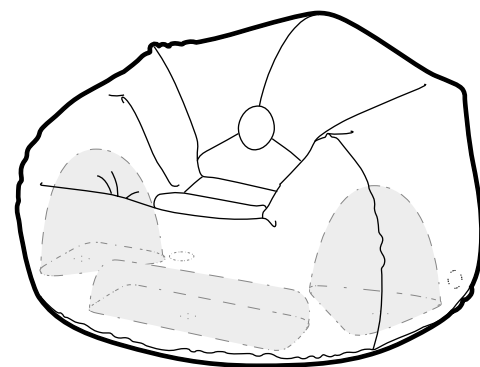

Beanless Bag™ chair inner structure
U.S. Patent No. 6,152,530, D441,205



Comfortable seating with side cup holder



Attractive contours from any angle, the beauty of this lounge chair is matched only by its comfort. Contact surfaces on the top and sides are lined with flocking for the touch of luxury. The side cup holder is just as indispensable here as in your favorite sports car.



RELAX AT HOME WITH OUR ULTRA LOUNGE

- 2-in-1 valve has extra-wide openings for fast inflating and deflating
- Convenient cup holder for refreshments
- Folds compactly for storage
- Shelf box

Item		Approximate Inflated Size	Case Pack	Case Weight
68564NP / EP	Chair	39" x 51" x 30" (99cm x 1.30m x 76cm)	4 ea	31.5 lb (14.3 kg)
	Ottoman	25" x 11" (64cm x 28cm)		

ULTRA LOUNGE

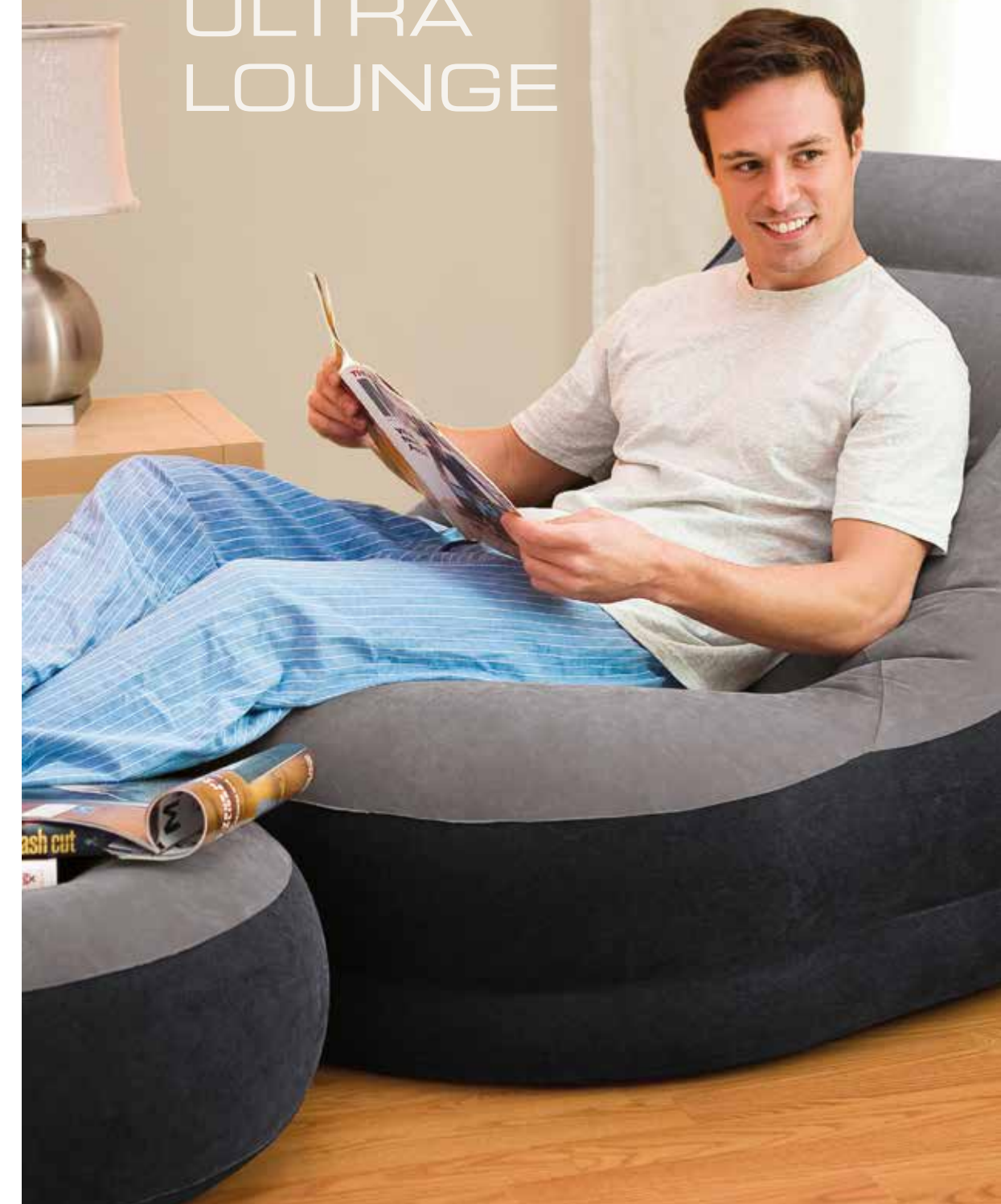

PULL-OUT CHAIR

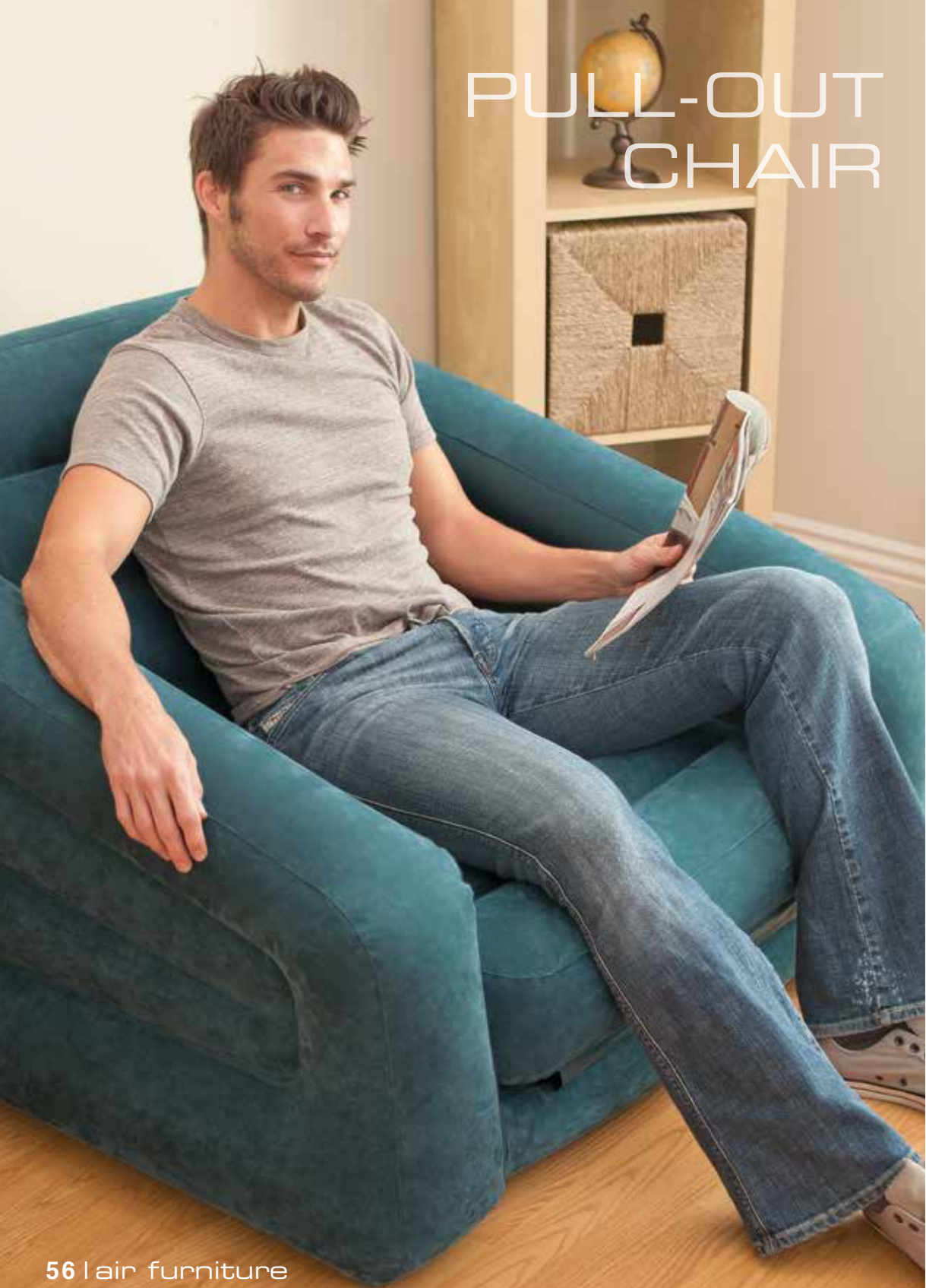

A perfect chair that transforms into a single bed! Not only is it comfortable, it's conveniently versatile. Ideal for college dorms, guest bedrooms and even on the road.

STURDY COMFORT

- 2-in-1 valve has extra-wide openings for fast inflating and deflating
- Folds compactly for storage
- Shelf box

Item	Approximate Inflated Size	Case Pack	Case Weight
68565NP / EP	43" x 86" x 26" (1.09m x 2.18m x 66cm)	2 ea	22.7 lb (10.3 kg)

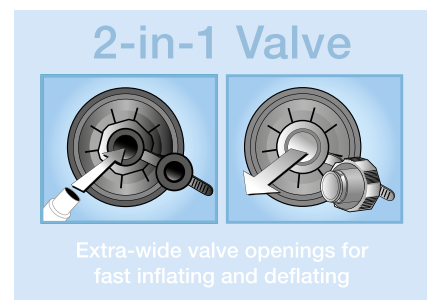
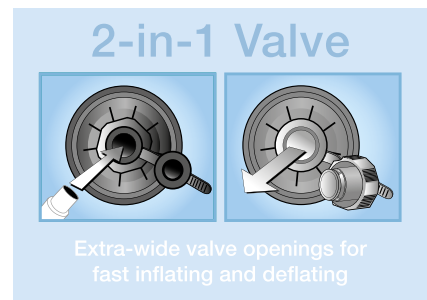

A versatile sofa that offers an affordable and comfortable sleeping solution for any home or even outdoor use. It is quick and easy to inflate and will seat or sleep two people.

PRACTICAL & VERSATILE

- 2-in-1 valve has extra-wide openings for fast inflating and deflating
- 2 quick inflation and deflation valves
- Comfortable backrest and armrest
- 2 cup holders
- Folds compactly for storage
- Shelf box

Item	Approximate Inflated Size	Case Pack	Case Weight
68566NP / EP	76" x 91" x 28" (1.93m x 2.31m x 71cm)	2 ea	43.0 lb (19.5 kg)



PULL-OUT SOFA

EMPIRE CHAIR



Modern, sophisticated and endlessly comfortable best describes this new addition to our line of inflatable chairs. In sunny orange, pink or lime green with an innovative transparent trim, this chair is the perfect combination of form and function. It's ideal for teens, college students and young professionals!

AN INVITING SPLASH OF COLOR AND COMFORT

- Extra strong laminated bottom for better durability
- Great for both indoors and outdoors
- Shelf box

Item	Approximate Inflated Size	Color	Case Pack	Case Weight
68581NP / EP	44" x 43" x 27" (1.12m x 1.09m x 69cm)	Green	3 ea	21.5 lb (9.8 kg)
68582NP / EP	44" x 43" x 27" (1.12m x 1.09m x 69cm)	3 Colors	3 ea, asst	21.5 lb (9.8 kg)



68581NP / EP

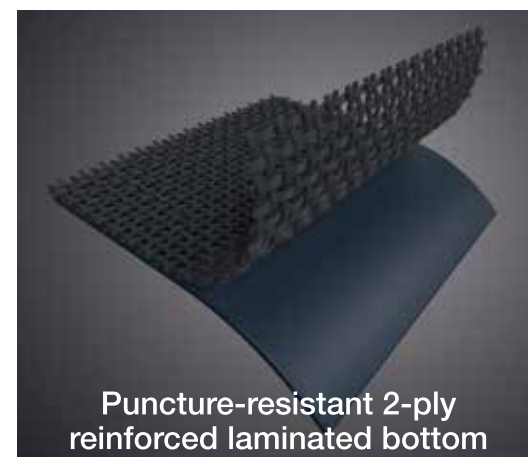

Puncture-resistant 2-ply reinforced laminated bottom



68582NP / EP



68583NP / EP

68584NP / EP



U.S. Patent No. 6,152,530, D441,205

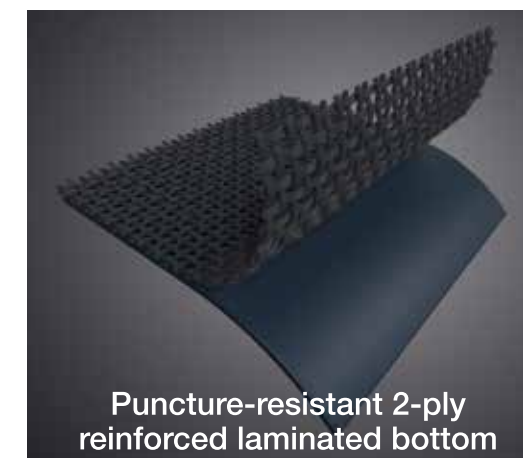

Puncture-resistant 2-ply reinforced laminated bottom

Taking our Beanless Bag™ Chair to the next level, this Deluxe version has a higher head rest and rich, velvety flocking reminiscent of cozy corduroy. The supportive and comfortable patented design is perfect for gaming, hanging out or just lazy down time. The reinforced bottom also makes this chair great for outdoor use on your patio, deck or lawn. Comes in sophisticated Classic Teal or Royal Grape.

COLORFUL CUSHY LUXURY

- Extra strong laminated bottom for better durability
- Great for both indoors and outdoors
- Shelf box

Item	Approximate Inflated Size	Color	Case Pack	Case Weight
68583NP / EP	48" x 50" x 32" (1.22m x 1.27m x 81cm)	Teal	4 ea	31.0 lb (14.1 kg)
68584NP / EP	48" x 50" x 32" (1.22m x 1.27m x 81cm)	Grape	4 ea	31.0 lb (14.1 kg)

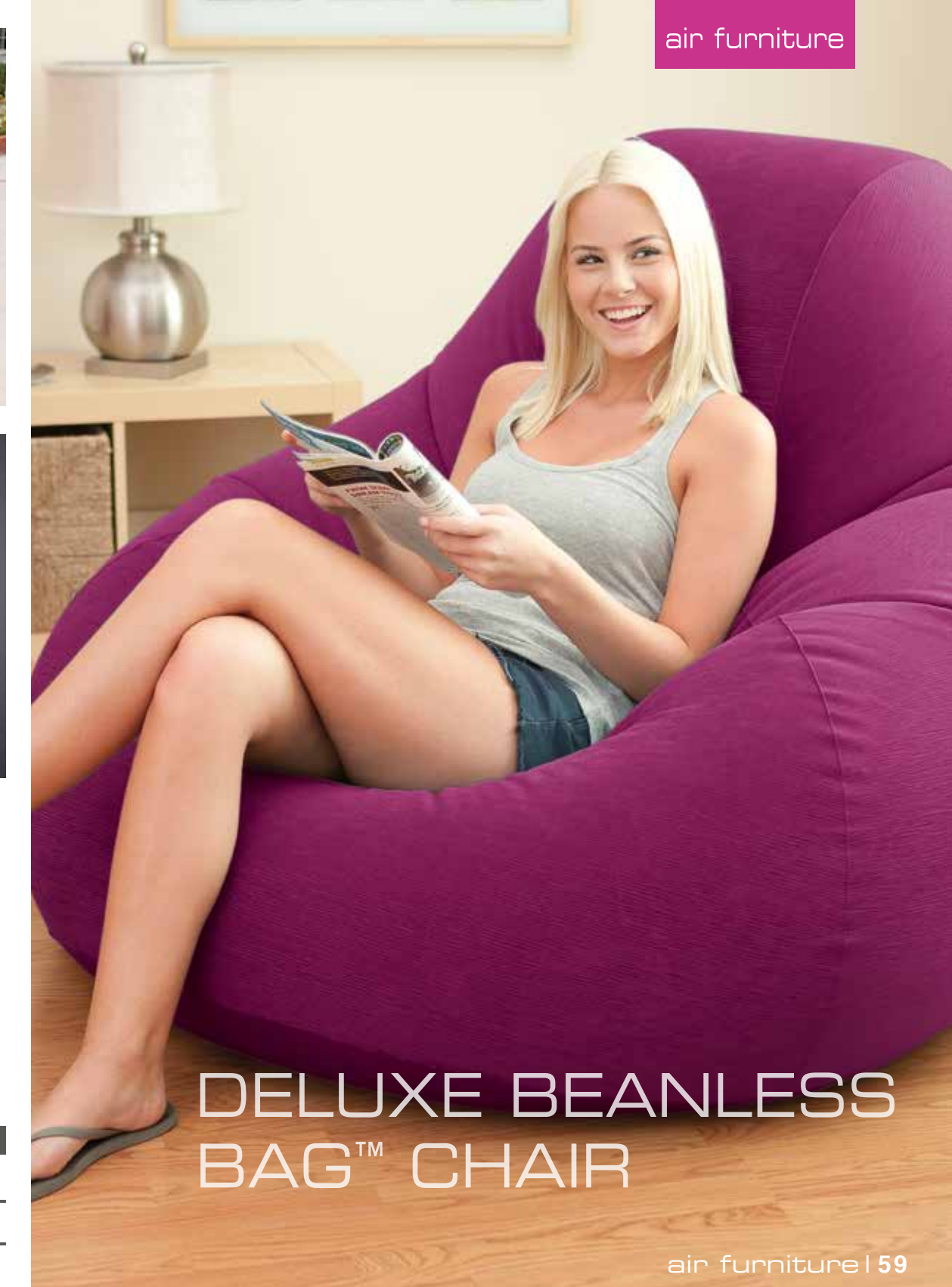

DELUXE BEANLESS BAG™ CHAIR

SPLASH LOUNGE



The Splash Lounge will look gorgeous indoors or outdoors. It's a great casual addition to any room. The reinforced bottom also makes it durable for lounging on the patio, yard or poolside.

PERFECTLY PORTABLE LOUNGE

- Extra strong laminated bottom for better durability
- Great for both indoors and outdoors
- Shelf box

Item	Approximate Inflated Size	Case Pack	Case Weight
68880NP / EP	33" x 67" x 32" (84cm x 1.70m x 81cm)	3 ea	21.1 lb (9.6 kg)

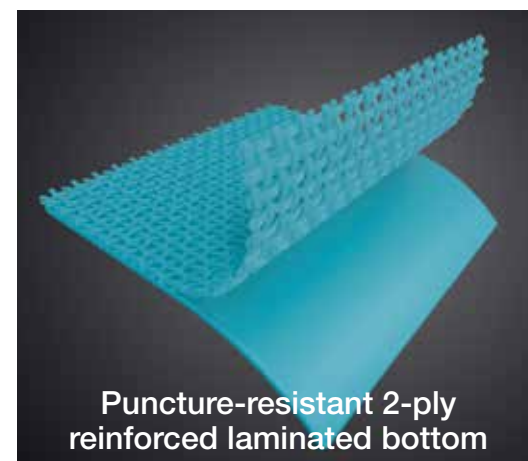

The Ultra Daybed Lounge invites you to relax, soak up the sun and hang out with friends. It's an elegant addition to any room, patio or yard as the reinforced bottom and soft flocking make it versatile enough for both indoors and outdoors.

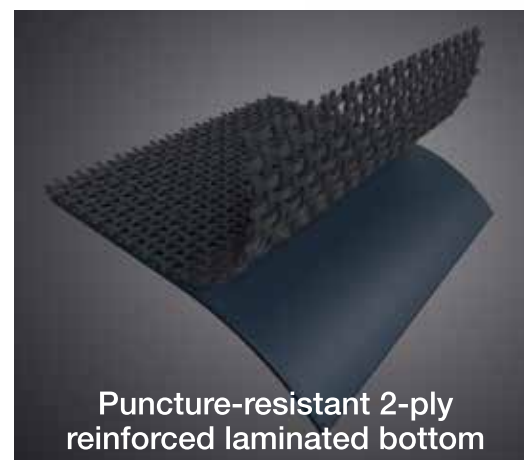

RELAX AT HOME WITH OUR ULTRA LOUNGE

- Detachable backrest for extra comfort and versatility
- Extra strong laminated bottom for better durability
- Great for both indoors and outdoors
- Quick coupling buckles for the backrest
- Shelf box

Item	Approximate Inflated Size	Case Pack	Case Weight
68881NP / EP	75" (D) x 21" (H) (1.91m x 53cm)	2 ea	35.4 lb (16.1 kg)



ULTRA DAYBED LOUNGE

CORNER SOFA

A corner sofa can be a fantastic addition to any living room. This beautifully designed piece is luxurious yet convenient. Create an intimate conversation area or an expansive seating arrangement for family and friends. Casual and comfortable, this sofa is designed with deep seats and wide armrests, and sleekly streamlined for sophisticated appeal.

SPACIOUS COMFORT AND CONVENIENCE

- Quality-tested waterproof flocked surface for a luxurious feel
- 2-in-1 valve with extra-wide openings for fast inflating and deflating
- Neutral color to suit any home decor
- Repair patch
- Shelf box



new!

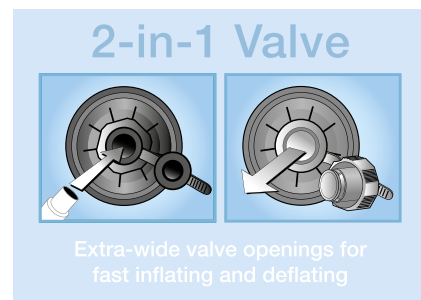

Item	Approximate Inflated Size	Case Pack	Case Weight
68575NP / EP	101" x 80" x 30" (2.57m x 2.03m x 76cm)	1 ea	27.8 lb (12.6 kg)

BLOSSOM CHAIR

new!



The perfect seat for reading or hanging out and chatting with friends, this super cozy chair is pretty enough for any girl's room! It's light and portable with a durable and stable structure.

SINK INTO COMFORT AND PRETTINESS

- These Blossom Chairs will add springtime brightness to any girl's room
- Vivid fuchsia and turquoise color assortment
- Shelf box



Item	Approximate Inflated Size	Case Pack	Case Weight
68574NP / EP	40" x 39" x 25" (1.02m x 99cm x 64cm)	6 ea, asst	26.7 lb (12.1 kg)



JR. CAFÉ CLUB CHAIR



Delight the little ones with this mini version of our hit Café Club Chair! They'll love being just like the grown ups in this version sized especially for them. Great for any child's bedroom or playroom in these pretty colors of Magenta Pink, Lime Green and Sunny Orange.

AN INVITING SPLASH OF COLOR AND COMFORT

- Kid-sized chair just like the grown ups
- Pink, orange and green color assortment
- Shelf box



Item	Approximate Inflated Size	Case Pack	Case Weight
68597NP / EP	27" x 22" x 19" (69cm x 56cm x 48cm)	6 ea, asst	18.5 lb (8.4 kg)





COZY KIDZ™ AIRBED

The perfect airbed for kids with soft, inflatable pillows in three fun and exciting colors! It will come in handy for sleepovers, nap time and travel, without sacrificing comfort or convenience!

COZY & FUN

- Assorted bright, fun colors
- Soft flocking for extra comfort
- Includes inflatable flocked pillow
- Repair patch
- Shelf box

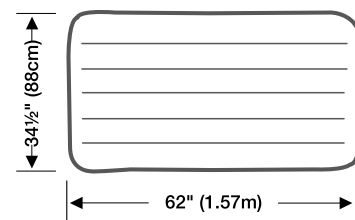

Item	Approximate Inflated Size	Case Pack	Case Weight
66801NP / EP	34½" x 62" x 7" (88cm x 1.57m x 18cm)	6 ea, asst	27.5 lb (12.5 kg)



Hand Pump (#68612)

Excellent solution to sleep comfortably when away from home. Perfect for trips, sleepovers, camping and even for nap times!

QUICK & EASY SOLUTION

- Includes hand pump
- Inner mattress size: 27" x 52" x 4" (69cm x 1.32m x 10cm)
- Uses standard crib sheets
- Inflates and deflates quickly
- Includes carry bag
- Shelf box



Sleep area is 27" x 52" (69cm x 1.32m) with soft frame surround



Item	Approximate Inflated Size	Hand Pump	Case Pack	Case Weight
66810NP / EP	42" x 66" x 10" (1.07m x 1.68m x 25cm)	68612	3 ea	29.3 lb (13.3 kg)



KIDZ TRAVEL BED SET

ACCESSORIES

PILLOWS



#68675 / E Travel Pillow
 • 14" x 12" x 4"
 (36cm x 30cm x 10cm)
 • Black super soft Velvetaire™ flocked surface
 • Perfect for those long plane and car trips
 • Contoured for neck support
 • Folds up for easy travel
 • Pegable box
 36 ea, 8.6 lb (3.9 kg)



#68672 / E Downy Pillow
 • 17" x 11" x 3½"
 (43cm x 28cm x 9cm)
 • Waterproof flocked top
 • I-beam construction
 • Pegable box
 24 ea, 10.4 lb (4.7 kg)



#68679 / E Lumbar Cushion
 • 17" x 13" x 4"
 (43cm x 33cm x 10cm)
 • Waterproof flocking for comfort and convenience
 • Superior design for lumbar support
 • Pegable box
 12 ea, 9.0 lb (4.1 kg)



#68678NP / EP Kidz Travel Pillows
 • Frog: 11" x 12" x 3"
 (28cm x 30cm x 8cm)
 • Cat: 12" x 11" x 3"
 (30cm x 28cm x 8cm)
 • Child-friendly designs
 • Soft flocking for extra comfort
 • Pegable box
 36 ea, asst 7.3 lb (3.3 kg)



#68676NP / EP Kidz Pillows
 • 17" x 11" x 3½"
 (43cm x 28cm x 9cm)
 • Available in Sunny Orange, Sky Blue and Lime Green
 • Pegable box
 24 ea, asst 10.4 lb (4.7 kg)

LED LIGHT



#68690 / E 5-in-1 LED Light
 • Optics design with 10x zoom lens
 • 360 degree beacon
 • Built-in battery compartment
 • Durable water resistant and impact resistant construction
 • Shelf box
 6 ea, 7.4 lb (3.4 kg)

FUNCTION	OPERATION
Flashlight	Choose between three power levels (8%, 50%, 100%) plus adjustable focus to meet all flashlight needs.
Hanging Lantern	Choose between three power levels to operate in floodlight mode with lantern suspended.
Table Top Lantern	Select lantern mode: 8% power level is perfect for a nightlight, while 50% and 100% levels are ideal to light up rooms, garages, RVs, or tents.
Hazard Light	Flashes an amber-colored warning light. A must-have for car & boat owners, campers, and other travelers.
Emergency Beacon	At full power, the international SOS signal autoflashes at up to a full kilometer, easily recognizable by rescue personnel.



Operates on 3 AAA batteries (not included)

#68691 / E Deluxe 5-in-1 LED Light
 • Built-in lithium rechargeable battery
 • Optics design with 10x zoom lens
 • 360 degree beacon
 • USB charger cable
 • 12V charger adaptor
 • Durable water resistant and impact resistant construction
 • Shelf box
 6 ea, 8.7 lb (3.9 kg)



12 volt charger adaptor

USB charger cable

ACCESSORIES



MANUAL PUMPS

#68612 / E Double Quick I Hand Pump

- 11½" (29cm)
- 3 interconnecting nozzles with hose
- TUV RL approved
- Inflates on both up and down strokes
- Shelf box
12 ea, 10.9 lb (5.0 kg)



#68614 / E Double Quick II Hand Pump

- 2 times the air flow of #68612
- 14" (36cm)
- 3 interconnecting nozzles with hose
- TUV RL approved
- Inflates on both up and down strokes
- Shelf box
4 ea, 6.1 lb (2.8 kg)



#68605 / E Double Quick III S Hand Pump

- 3 times the air flow of #68612
- 14½" (37cm)
- 3 interconnecting nozzles with hoses
- TUV RL approved
- Inflates and deflates
- Pumps on up and down strokes
- Shelf box
3 ea, 6.5 lb (3.0 kg)



#68615 / E Double Quick III Hand Pump

- 3½ times the air flow of #68612
- 19" (48cm)
- TUV RL approved
- Large nozzle threaded for athletic ball inflating needle (one included)
- Inflates athletic balls up to 8 psi
- Inflates and deflates
- Pumps on up and down strokes
- Shelf box
3 ea, 9.0 lb (4.1 kg)



U.S. Patent
No. 6,299,420

#69613 / E Double Quick Mini Hand Pump

- 11½" (29cm)
- TUV RL approved
- Inflates on fore and back strokes
- Hose with graduated nozzle
- 24 ea, 8.3 lb (3.8 kg)



#69611 / E Bellows Foot Pump

- 11" (28cm)
- TUV RL approved
- Inflates and deflates
- Shrink wrapped with litho label
- 6 ea, 8.4 lb (3.8 kg)



#68610 / E Giant Bellows Foot Pump

- 50% more air flow than of #69611
- 12" (30cm)
- TUV RL approved
- Inflates and deflates
- Shelf box
6 ea, 13.6 lb (6.2 kg)



ACCESSORIES

ELECTRIC PUMPS

These Quick-Fill™ electric pumps have a sleek, aerodynamic design that fits perfectly in the palm of your hand, yet still inflate even the largest of inflatables in a breeze.

Quick-Fill™ AC/DC Electric Pump features include:

- 3 interconnecting nozzles
- 12V DC & AC power adapter for easy Outdoor and Indoor use
- ETL approved (110-120V)
- CE approved (220-240V)
- Shelf box



#66631 (110-120V)
#66632 (220-240V)

Quick-Fill™ DC Electric Pump features include:

- 3 interconnecting nozzles
- Plug into 12V DC automobile cigarette lighter or 12V DC accessory outlet
- ETL approved
- CE, GS approved
- Shelf box



#66626 (12V)

Quick-Fill™ AC Electric Pump features include:

- 3 interconnecting nozzles
- Thermo protector incorporated for safety
- ETL approved (110-120V)
- CE, GS approved (220-240V)
- Shelf box



#66619 (110-120V)
#66620 (220-240V)

Quick-Fill™ RECHARGEABLE Pump features include:

- 3 interconnecting nozzles
- A 12V DC power adapter for vehicle charging and a household AC power adapter for home charging
- 12V DC to inflate and deflate while recharging
- Automatic over-charge cut off for safety protection
- New shape with easy carry handle
- ETL approved (110-120V)
- CE approved (220-240V)
- Shelf box



#66621 (110-120V)
#66622 (220-240V)

Quick-Fill™ AC Electric Pump features include:

- 3 interconnecting nozzles with hose
- Thermo protector incorporated for safety
- New shape with easy carry handle
- ETL approved (110-120V model)
- CE, GS approved (220-240V model)
- Shelf box



#66623 (110-120V)
#66624 (220-240V)

Quick-Fill™ High PSI Indoor/outdoor Electric Pump features include:

- 3 interconnecting nozzles with hose
- For both indoor and outdoor use - plugs into cigarette lighter or household electrical outlet
- 2-speed switch
- Inflates athletic balls up to 12 psi
- Detachable DC cigarette cord
- ETL approved (110-120V)
- CE, GS approved (220-240V)
- Shelf box



#68608 (110-120V)
#68609 (220-240V)

Quick-Fill™ BATTERY Pump features include:

- 24% more air flow than previous version (#68639)
- Operates on 6 C-cell size batteries
- 3 interconnecting nozzles
- CE approved
- Shelf box

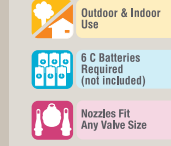

#68638

Item #	Voltage			Disposable Batteries	Outdoor Use	Accordion Hose with 3 Nozzles	3 Interconnecting Nozzles	Max. Air Flow (L/min)	Case Pack	Weight lb (kg)
	110-120 AC	220-240 AC	12 DC							
66631E	•		•		•		•	≥450 (15.9CFM)	6	13.0 (5.9)
66632		•	•		•		•	≥450 (15.9CFM)	6	13.1 (6.0)
68638 / E				6 x C	•		•	≥380 (13.4CFM)	6	6.4 (2.9)
66626 / E			•		•		•	≥600 (21.2CFM)	6	8.7 (4.0)
66619E	•						•	≥600 (21.2CFM)	6	8.8 (4.0)
66620		•					•	≥600 (21.2CFM)	6	8.8 (4.0)
66623E	•					•	•	≥1100 (38.9CFM)	4	11.1 (5.1)
66624		•				•	•	≥1100 (38.9CFM)	4	11.1 (5.1)
68608E	•		•		•	•	•	≥400 (14.1CFM)	4	30.1 (13.7)
68609		•	•		•	•	•	≥400 (14.1CFM)	4	30.1 (13.7)
66621E	•		•		•		•	≥600 (21.2CFM)	4	10.8 (4.9)
66622		•	•		•		•	≥600 (21.2CFM)	4	11.1 (5.0)

PREMIUM COMFORT AIRBED **64403**
DURA-BEAM®

AIRBED WITH BUILT-IN ELECTRIC PUMP

Item	Size	Approximate Inflated Size	Built-in Pump
64403E	Queen	60" x 80" x 13" (1.52m x 2.03m x 33cm)	110 - 120V
64404/ES			220 - 240V
64407E	Queen	60" x 80" x 18" (1.52m x 2.03m x 46cm)	110 - 120V
64408/ES			220 - 240V

64403
P.18-19

DELUXE SINGLE-HIGH AIRBED **64701**
DURA-BEAM®

AIRBED ONLY

Item	Size	Approximate Inflated Size
64701/E	Twin	39" x 75" x 10" (99cm x 1.91m x 25cm)
64702/E	Full	54" x 75" x 10" (1.37m x 1.91m x 25cm)
64703/E	Queen	60" x 80" x 10" (1.52m x 2.03m x 25cm)

new! 64701
P.14-15

PILLOW REST RAISED BED **66721**

AIRBED ONLY

Item	Size	Approximate Inflated Size
66721/E	Twin	39" x 75" x 16½" (99cm x 1.91m x 42cm)
66720/E	Queen	60" x 80" x 16½" (1.52m x 2.03m x 42cm)

AIRBED WITH BUILT-IN ELECTRIC PUMP

Item	Size	Approximate Inflated Size	Built-in Pump
66705E	Twin	39" x 75" x 16½" (99cm x 1.91m x 42cm)	110 - 120V
66706			220 - 240V
67701E	Queen	60" x 80" x 16½" (1.52m x 2.03m x 42cm)	110 - 120V
66702			220 - 240V

66721
P.36

KIDZ TRAVEL BED SET **66810**

KIDZ TRAVEL BED SET

Item	Approximate Inflated Size	Hand Pump
66810NP/EP	42" x 66" x 10" (1.07m x 1.68m x 25cm)	68612

66810
P.67

DELUXE PILLOW REST RAISED BED **67736**

AIRBED ONLY

Item	Size	Approximate Inflated Size
67736/E	Queen	60" x 80" x 16¾" (1.52m x 2.03m x 43cm)

AIRBED WITH BUILT-IN ELECTRIC PUMP

Item	Size	Approximate Inflated Size	Built-in Pump
67731E	Twin	39" x 75" x 16¾" (99cm x 1.91m x 43cm)	110 - 120V
67732			220 - 240V
67737E	Queen	60" x 80" x 16¾" (1.52m x 2.03m x 43cm)	110 - 120V
67738			220 - 240V

67736
P.37

FOAM TOP BED **67953**

AIRBED WITH BUILT-IN ELECTRIC PUMP

Item	Size	Approximate Inflated Size	Built-in Pump
67953E	Queen	60" x 80" x 20" (1.52m x 2.03m x 51cm)	110 - 120V
67954			220 - 240V

67953
P.46-47

COMFORT-PLUSH ELEVATED AIRBED **64411**
DURA-BEAM®

AIRBED WITH BUILT-IN ELECTRIC PUMP

Item	Size	Approximate Inflated Size	Built-in Pump
64411E	Twin	39" x 75" x 18" (99cm x 1.91m x 46cm)	110 - 120V
64412/ES			220 - 240V
64413E	Queen	60" x 80" x 18" (1.52m x 2.03m x 46cm)	110 - 120V
64414/ES			220 - 240V

64411
P.16-17

ROLL 'N GO™ BED **64780**
DURA-BEAM®

AIRBED WITH HAND PUMP

Item	Size	Approximate Inflated Size	Hand Pump
64780/E	JR. Twin	30" x 75" x 5" (76cm x 1.91m x 13cm)	68612

new! 64780
P.12

PILLOW REST CLASSIC BED **66767**

AIRBED ONLY

Item	Size	Approximate Inflated Size
66767/E	Twin	39" x 75" x 9" (99cm x 1.91m x 23cm)
66768/E	Full	54" x 75" x 9" (1.37m x 1.91m x 23cm)
66769/E	Queen	60" x 80" x 9" (1.52m x 2.03m x 23cm)
66770/E	King	72" x 80" x 9" (1.83m x 2.03m x 23cm)

AIRBED WITH BUILT-IN ELECTRIC PUMP

Item	Size	Approximate Inflated Size	Built-in Pump
66775E	Twin	39" x 75" x 9" (99cm x 1.91m x 23cm)	110 - 120V
66779			220 - 240V
66776E	Full	54" x 75" x 9" (1.37m x 1.91m x 23cm)	110 - 120V
66780			220 - 240V
66777E	Queen	60" x 80" x 9" (1.52m x 2.03m x 23cm)	110 - 120V
66781			220 - 240V

66767
P.34

DOWNY BED **66950**

AIRBED WITH BUILT-IN FOOT PUMP

Item	Size	Approximate Inflated Size
66950/E	JR. Twin	30" x 75" x 8¾" (76cm x 1.91m x 22cm)
66927/E	Twin	39" x 75" x 8¾" (99cm x 1.91m x 22cm)
66928/E	Full	54" x 75" x 8¾" (1.37m x 1.91m x 22cm)
66929/E	Queen	60" x 80" x 8¾" (1.52m x 2.03m x 22cm)

66950
P.27

PILLOW REST MID-RISE BED **67741**

AIRBED WITH BUILT-IN ELECTRIC PUMP

Item	Size	Approximate Inflated Size	Built-in Pump
67741E	Twin	39" x 75" x 13¾" (99cm x 1.91m x 35cm)	110 - 120V
67742			220 - 240V
67747E	Queen	60" x 80" x 13¾" (1.52m x 2.03m x 35cm)	110 - 120V
67748			220 - 240V

67741
P.35

CAMPING MATS **68797**

CAMPING MAT

Item	Approximate Inflated Size
68797/E	26½" x 72½" x 6¾" (67cm x 1.84m x 17cm)
68798/E	28½" x 74½" x 8" (72cm x 1.89m x 20cm)
68799/E	50" x 76" x 9½" (1.27m x 1.93m x 24cm)

68797
P.26

COMFORT-PLUSH HIGH-RISE AIRBED **64417**
DURA-BEAM®

AIRBED WITH BUILT-IN ELECTRIC PUMP

Item	Size	Approximate Inflated Size	Built-in Pump
64417E	Queen	60" x 80" x 22" (1.52m x 2.03m x 56cm)	110 - 120V
64418/ES			220 - 240V

64417
P.16-17

SUPER-TOUGH™ AIRBED **64790**
DURA-BEAM®

AIRBED ONLY

Item	Size	Approximate Inflated Size
64790/E	JR. Twin	30" x 75" x 6" (76cm x 1.91m x 15cm)

AIRBED WITH BUILT-IN BATTERY PUMP

Item	Size	Approximate Inflated Size
64791/E	Twin	39" x 75" x 8" (99cm x 1.91m x 15cm)

new! 64790
P.13

PILLOW REST CLASSIC BED **66767**

AIRBED WITH BUILT-IN ELECTRIC PUMP

Item	Size	Approximate Inflated Size	Built-in Pump
66775E	Twin	39" x 75" x 9" (99cm x 1.91m x 23cm)	110 - 120V
66779			220 - 240V
66776E	Full	54" x 75" x 9" (1.37m x 1.91m x 23cm)	110 - 120V
66780			220 - 240V
66777E	Queen	60" x 80" x 9" (1.52m x 2.03m x 23cm)	110 - 120V
66781			220 - 240V

66767
P.34

SUPREME AIR-FLOW BED **66963**

AIRBED WITH BUILT-IN ELECTRIC PUMP

Item	Size	Approximate Inflated Size	Built-in Pump
66963E	Twin	39" x 75" x 20" (99cm x 1.91m x 51cm)	110 - 120V
66964			220 - 240V
66961E	Queen	60" x 80" x 20" (1.52m x 2.03m x 51cm)	110 - 120V
66962			220 - 240V

66963
P.44-45

COMFORT-PLUSH MID-RISE AIRBED **67765**
DURA-BEAM®

AIRBED WITH BUILT-IN ELECTRIC PUMP

Item	Size	Approximate Inflated Size	Built-in Pump
67765E	Twin	39" x 75" x 13" (99cm x 1.91m x 33cm)	110 - 120V
67766/ES			220 - 240V
67767E	Full	54" x 75" x 13" (1.37m x 1.91m x 33cm)	110 - 120V
67768/ES			220 - 240V
67769E	Queen	60" x 80" x 13" (1.52m x 2.03m x 33cm)	110 - 120V
67770/ES			220 - 240V

67765
P.16-17

CLASSIC DOWNY BED **68950**

AIRBED ONLY

Item	Size	Approximate Inflated Size
68950/E	JR. Twin	30" x 75" x 8¾" (76cm x 1.91m x 22cm)
68757/E	Twin	39" x 75" x 8¾" (99cm x 1.91m x 22cm)
68758/E	Full	54" x 75" x 8¾" (1.37m x 1.91m x 22cm)
68759/E	Queen	60" x 80" x 8¾" (1.52m x 2.03m x 22cm)
68755/E	King	72" x 80" x 8¾" (1.83m x 2.03m x 22cm)

AIRBED SET
Includes two I-beam pillows 17" x 11" x 3½" (43cm x 28cm x 9cm) and a #68612 Double-Quick air pump

Item	Size	Approximate Inflated Size	Hand Pump
68765/E	Queen	60" x 80" x 8¾" (1.52m x 2.03m x 22cm)	68612

68950
P.30-31

PREMAIRE™ AIRBED **64471**
PREMAIRE™

AIRBED WITH BUILT-IN ELECTRIC PUMP

Item	Size	Approximate Inflated Size	Built-in Pump
64471E	Twin	39" x 75" x 18" (99cm x 1.91m x 46cm)	110 - 120V
64472/ES			220 - 240V
64473E	Queen	60" x 80" x 18" (1.52m x 2.03m x 46cm)	110 - 120V
64474/ES			220 - 240V

new! 64471
P.22-23

RAISED DOWNY BED **66717**

AIRBED WITH BUILT-IN ELECTRIC PUMP

Item	Size	Approximate Inflated Size	Built-in Pump
66717E	Queen	60" x 80" x 22" (1.52m x 2.03m x 56cm)	110 - 120V
66718			220 - 240V

66717
P.38-39

COZY KIDZ™ AIRBED **66801**

COZY KIDZ™ AIRBED

Item	Approximate Inflated Size
66801NP/EP	34½" x 62" x 7" (88cm x 1.57m x 18cm)

66801
P.66

PRESTIGE DOWNY BED **66967**

AIRBED WITH SEPARATE BATTERY PUMP (6 X C-CELL)

Item	Size	Approximate Inflated Size
66967/E	Twin	39" x 75" x 8¾" (99cm x 1.91m x 22cm)
66968/E	Full	54" x 75" x 8¾" (1.37m x 1.91m x 22cm)
66969/E	Queen	60" x 80" x 8¾" (1.52m x 2.03m x 22cm)

66967
P.28-29

ULTRA PLUSH BED **67951**

AIRBED WITH BUILT-IN ELECTRIC PUMP

Item	Size	Approximate Inflated Size	Built-in Pump
67951E	Twin	39" x 75" x 18" (99cm x 1.91m x 46cm)	110 - 120V
67952			220 - 240V
66957E	Queen	60" x 80" x 18" (1.52m x 2.03m x 46cm)	110 - 120V
66958			220 - 240V

67951
P.42-43

CLASSIC DOWNY BED **68950**

AIRBED ONLY

Item	Size	Approximate Inflated Size
68950/E	JR. Twin	30" x 75" x 8¾" (76cm x 1.91m x 22cm)
68757/E	Twin	39" x 75" x 8¾" (99cm x 1.91m x 22cm)
68758/E	Full	54" x 75" x 8¾" (1.37m x 1.91m x 22cm)
68759/E	Queen	60" x 80" x 8¾" (1.52m x 2.03m x 22cm)
68755/E	King	72" x 80" x 8¾" (1.83m x 2.03m x 22cm)

AIRBED SET
Includes two I-beam pillows 17" x 11" x 3½" (43cm x 28cm x 9cm) and a #68612 Double-Quick air pump

Item	Size	Approximate Inflated Size	Hand Pump
68765/E	Queen	60" x 80" x 8¾" (1.52m x 2.03m x 22cm)	68612

68950
P.30-31